



A R K T U R A



Atmosfera[®] Contour 3D



Adaptive Ceiling Baffles

Our Key Features

Contour 3D combines the flexibility of all the Atmosphaera® systems into a limitless canvas to suit your custom needs. Your design will beautifully flow in the fin direction while capturing a layered undulating landscape in the other. The combination of the two generates a dynamic surface that is awe inspiring. Don't limit your movement to just one direction; instead, go for bold and create a truly one-of-a-kind design that stuns. Contour 3D's panels are available in either powder-coated steel, for a bold look, or in our Soft Sound® material, for acoustic comfort.

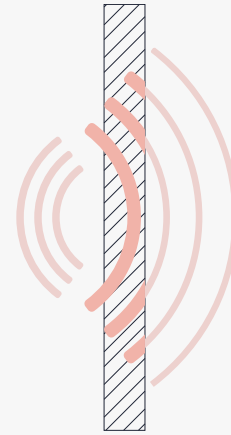

Reduce Noise & Enhance Acoustics

Atmosfera®'s Soft Sound® material reduces the impact of noise from everyday annoyances like ringing, typing, and chatter resulting in a more pleasant and productive environment. Atmosphaera®'s material works in concert with the design to help reduce and control reverberations leaving a lasting impression at scales ranging from assembly halls to conference rooms.

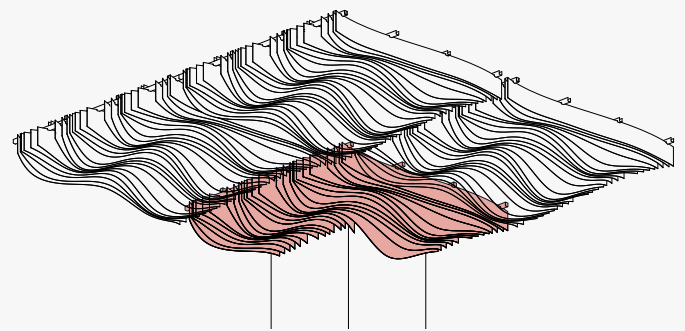

No Field Trimming Necessary

All modules are built to your unique project specifications, removing the need for any field trimming and assuring easy installation.



Scan the QR or Click to Learn More about Atmosphaera®

Our Key Features

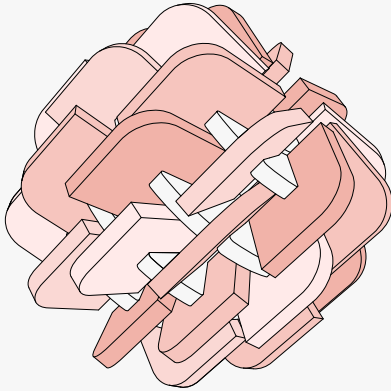

Expansive Color Library

Choose from a large library of Soft Sound® colors and wood textures. Mix and match colors to accent fins and complement the color scheme of your space.

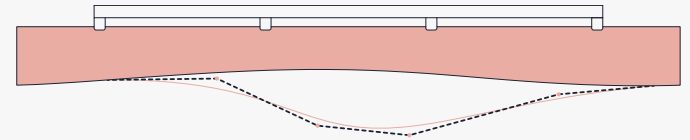

Customizable Topography

Atmosphera® offers a range of configurable options, allowing you to customize fin topography to fit your space and design vision, with the help of our project team.

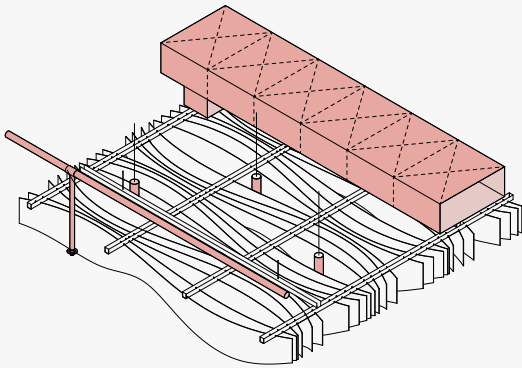

Open Plan Accessibility

Atmosphera®'s open design makes integrating systems above or below the modules simple and feasible. Easily removable fins and open structure makes accessing lights, HVAC, rigging points, plumbing, AV equipment, and life safety systems easy for your maintenance team.

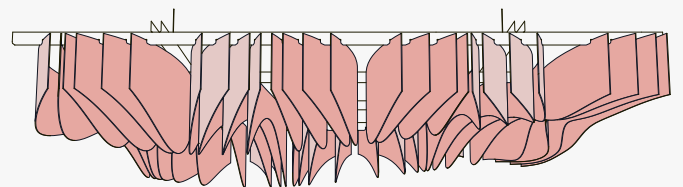

Dynamic Looks From All Angles

The wavering undulations of Atmosphera® fins provide great looks from wherever you are looking. Steel or Soft Sound® fins offer proprietary curved baffle system with no visible hardware.

Inspiration



Dynamic Textured Ceiling



Customize Fin Curves and Depth for a Unique Effect

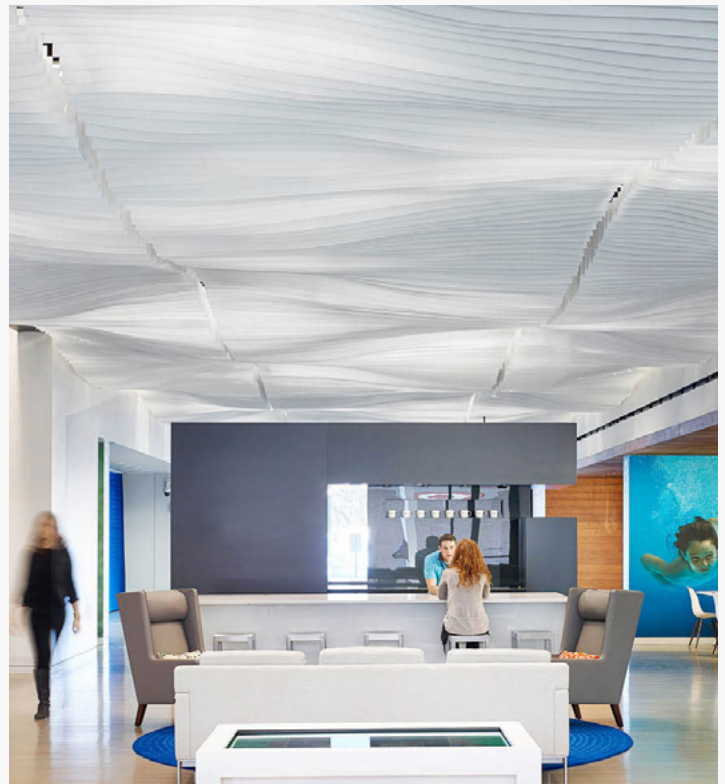

Create Dynamic Lighting

Overview

- 1 Customization Process

2 Understanding the System
- 3 Available Finishes

4 Product Specifications

1 Customization Process

Our project management team will pre-design all of the modules to work in your space. We will coordinate around columns, lights, HVAC, building envelope, and partitions as needed.

The topography and curvature will be generated by our team to reach your desired look. You can provide us with inspiration, a description (i.e. turbulent, rolling, responsive to floor plan, etc.), an image, or ask our team to create a unique look for your project.

Nested pendant light

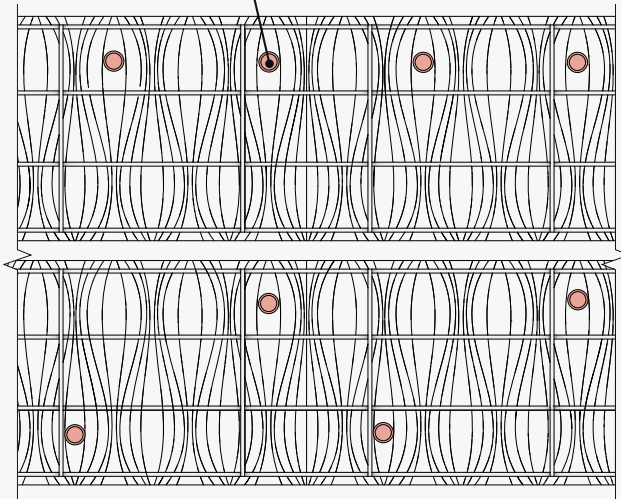

Ambient Pendant Light

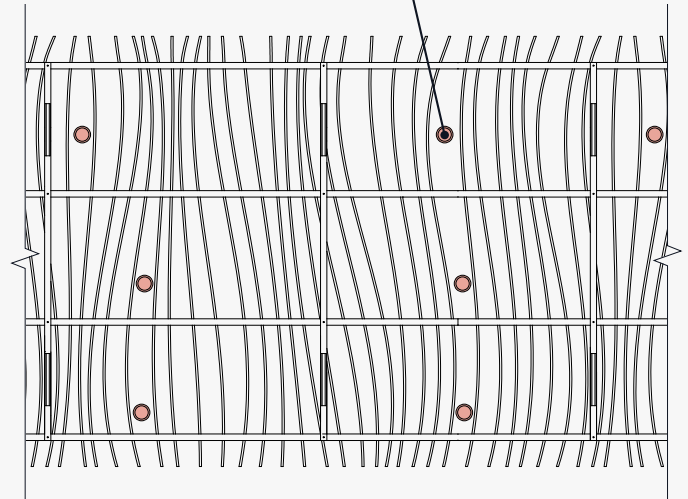

2 Understanding the System

Single Module

Atmosfera® Contour 3D's curving fins are available in both Arktura's lightweight & durable Soft Sound® acoustical material and steel.

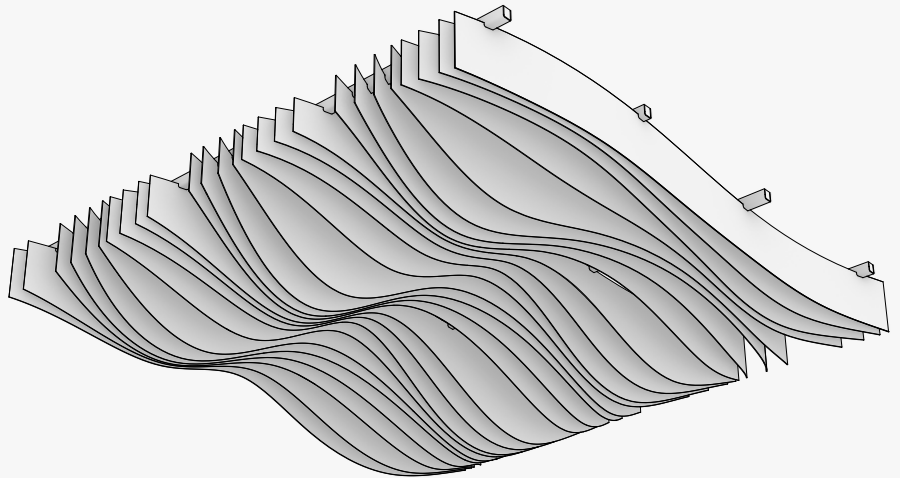

Soft Sound® fin

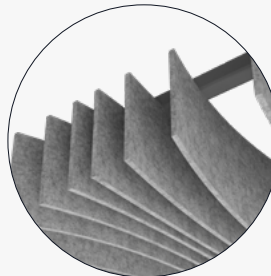

12 mm

Steel fin

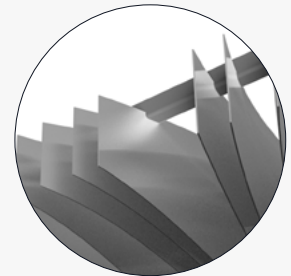

20 GA

Multiple Modules

Modules can be continuously tiled in multiple directions in plan, using the provided connecting brackets.

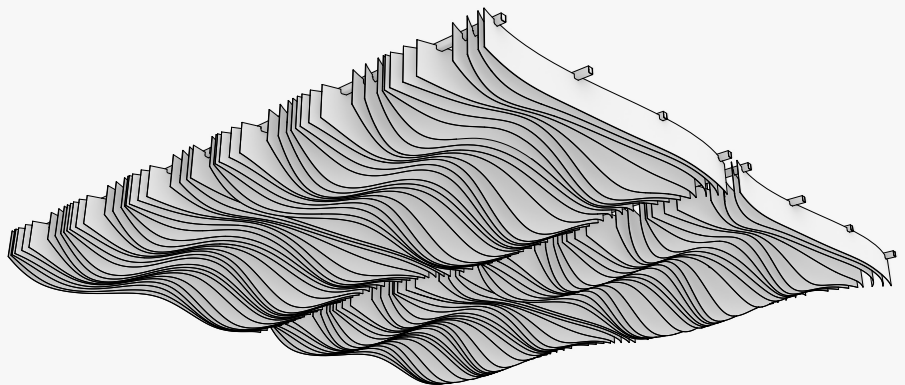

2 Understanding the System

Understanding the Module

Plan

Atmosfera® Contour 3D lets you design undulations in plan. Create flowing designs that create your desired look while adapting to and concealing building elements such as sensors, sprinklers, and lighting.

Steel: 93% Open
Soft Sound®: 83%

--- Gap between Module Fins.
(1" Fin End to Fin End)

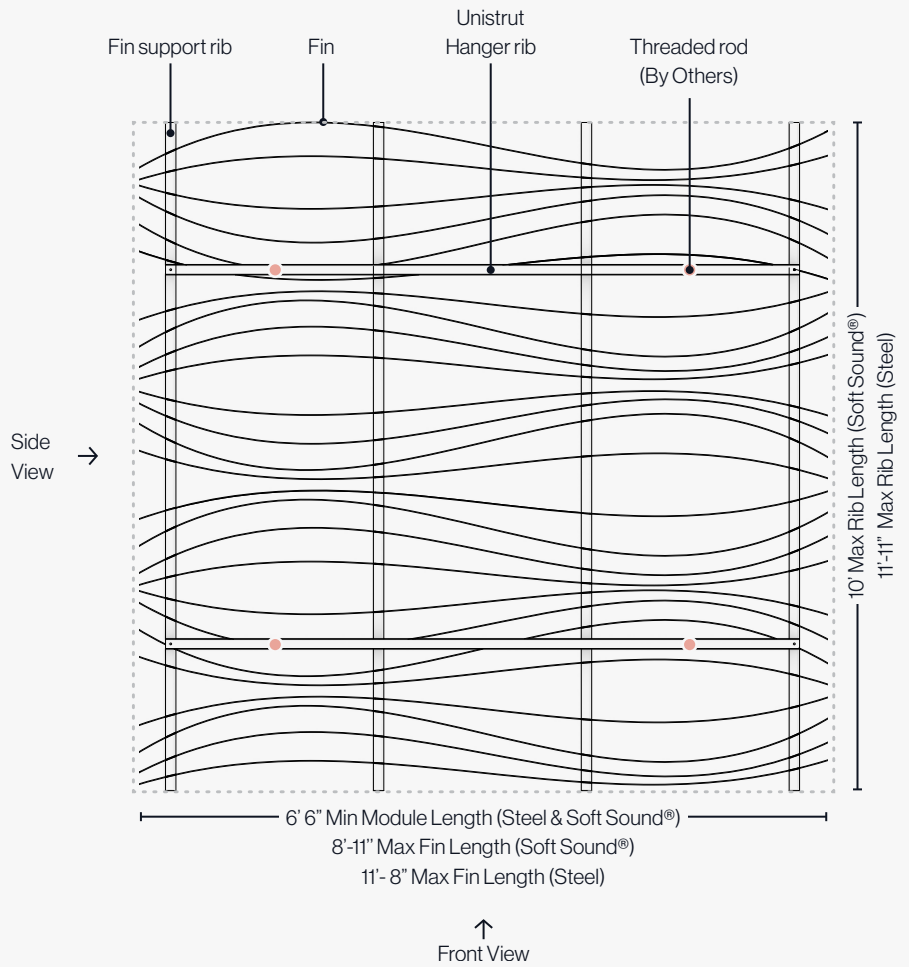

Elevation

Define the depth and length of the undulations of your design across your space in elevation, using a range of depths from 5" to 16". Create subtle ebbs or more turbulent waves.

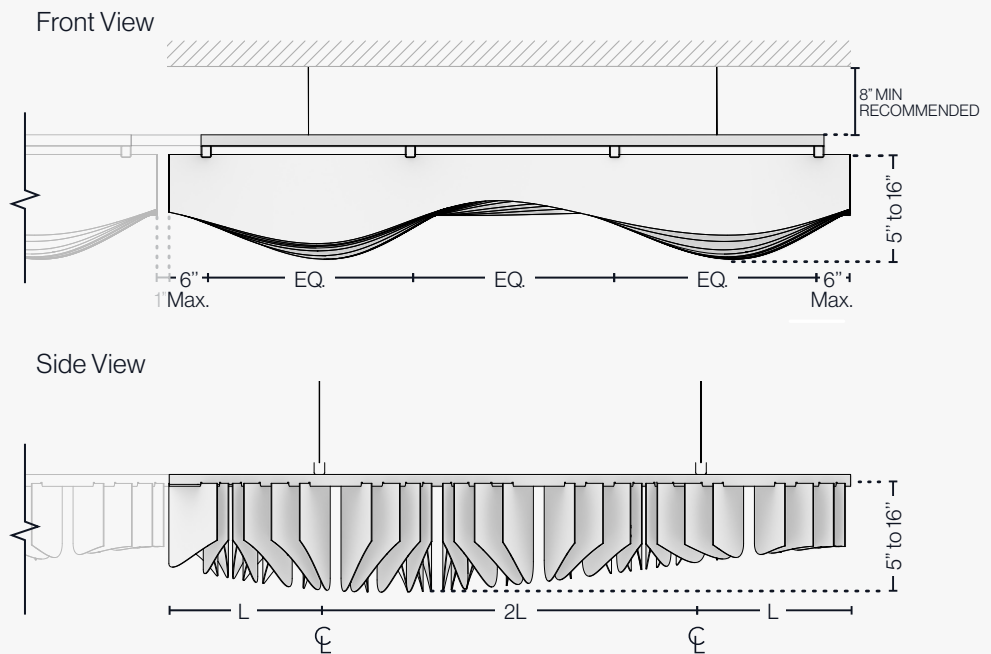

2 Understanding the System

Attachment Details

Atmosfera® systems are designed for ease of install and assembly. Use available joining brackets to achieve seamless fin to fin connections across modules with ease.

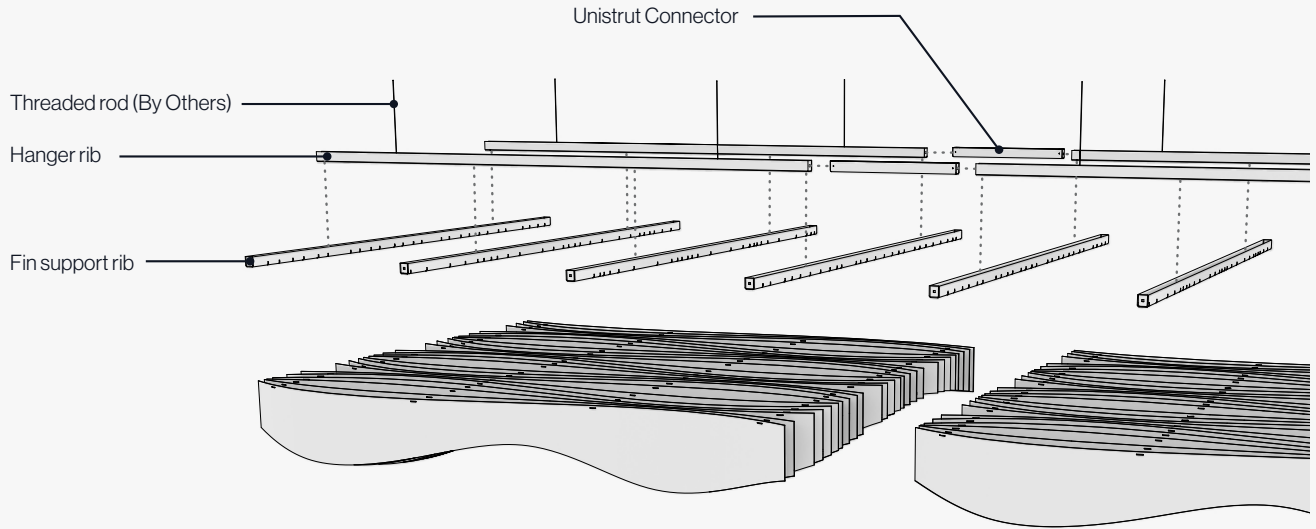

Multiple Modules Grid

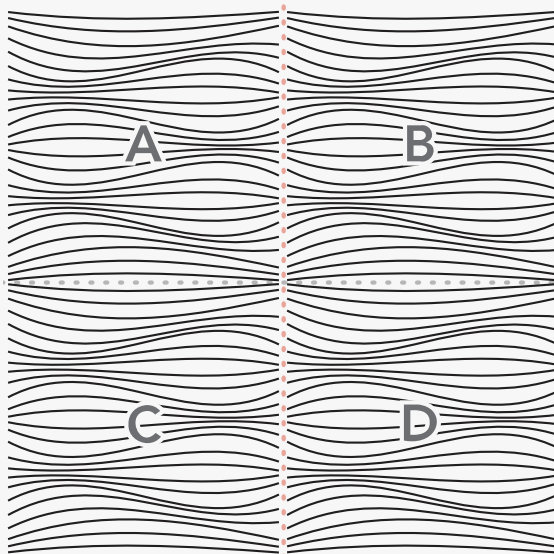

1" Gap between Module Fins.

Unistrut Connector and Rib End to End Connection

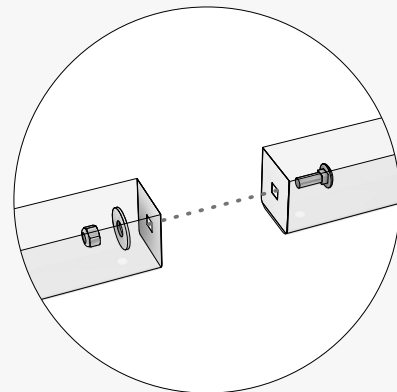

3 Available Finishes

Soft Sound® Fins

**Soft Sound®
Vivids**
Standard

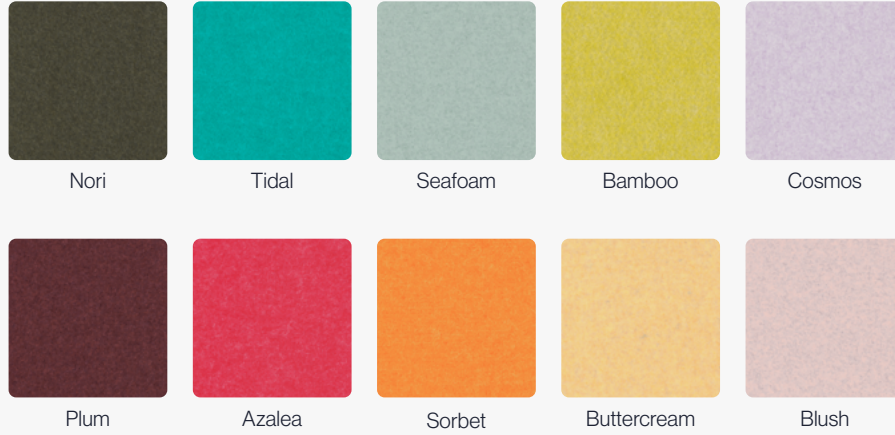

**Soft Sound®
Elementals**
Standard

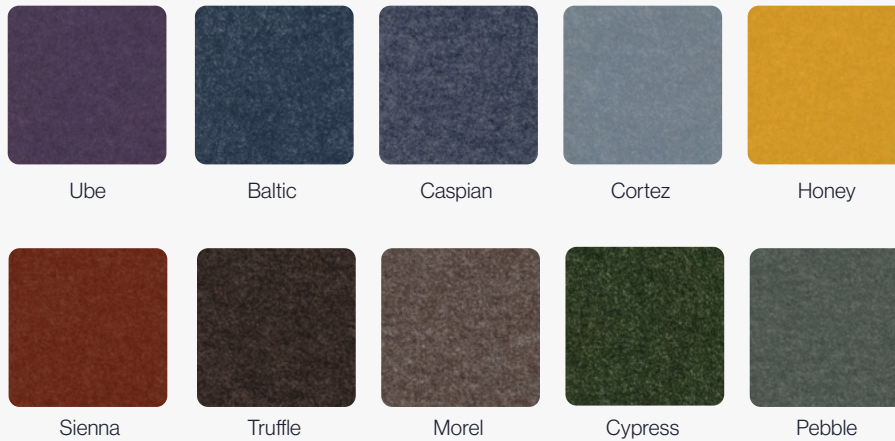

⚠ Due to the nature of non-woven materials, light may pass through Soft Sound® in any thickness or color. A translucent appearance is most apparent in lighter colors and thin material when a light source is present behind the material. Arktura makes no claims or warranties about the material performing as opaque in any circumstance. To verify a products performance for light transmittance, a mockup of the specific intended use is recommended.

3 Available Finishes

Soft Sound® Fins

Soft Sound® Essentials
Standard



Soft Sound® Wood Texture
Premium

i As with natural wood, variation in color and grain is expected and grain will not align across panels.

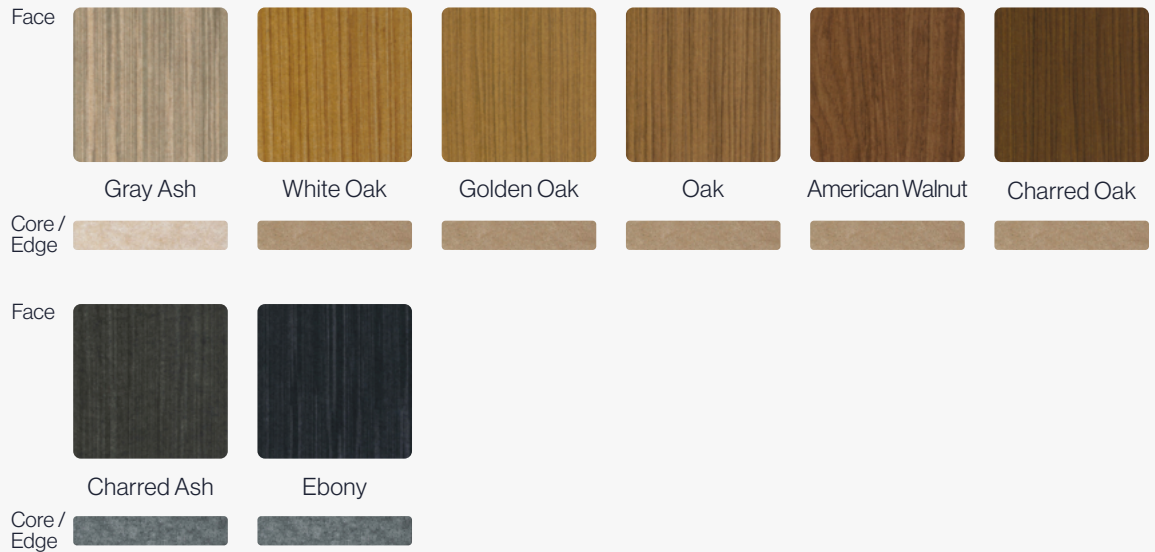

! Due to the nature of non-woven materials, light may pass through Soft Sound® in any thickness or color. A translucent appearance is most apparent in lighter colors and thin material when a light source is present behind the material. Arktura makes no claims or warranties about the material performing as opaque in any circumstance. To verify a products performance for light transmittance, a mockup of the specific intended use is recommended.

3 Available Finishes

Steel Fins

Powder Coat
Standard Finish
Inspired by our
Vivids Collection



Powder Coat
Standard Finish
Inspired by our
Elementals Collection

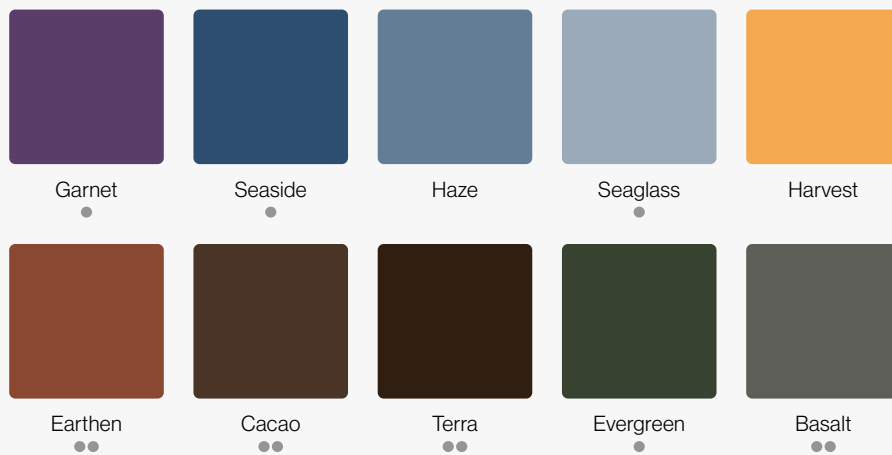

Available in:

- AAMA 2604 Color
- AAMA 2604 or 2605 Color

* Non stock, fee **upcharge**



3 Available Finishes

Steel Fins

Powder Coat
Standard Finish
Inspired by our
Essentials Collection

					
T-Grid White* (Matte) ••	Arktura White (Matte) ••	Brilliant White* (Gloss) •	Silver Metallic (Semi Gloss) ••	Jet Black (Matte) ••	
					
Aviator Gray (Gloss) ••	Aviator Gray (Matte) ••	Steel Gray ••	Shadow ••	Midnight ••	Coffee •
					
Raw Umber •	Caramel ••	Sandstone ••	Oat ••	Sunflower* •	Torch •
					
Spirit Red (Matte) •	Redwood •	Boysenberry •	Azure* •	Blue Steel* •	Harbor Blue •
					
Forest Green ••	Hartford Green •				

Powder Coat
Premium Metallic
Finish

		
Chilled Champagne (Semi Gloss) ••	Sun Kissed Bronze •	Burnished Bronze (Semi Gloss) ••

Custom Powder Colors
We offer premium non-stock RAL and custom color match options as well. Contact your sales rep for more information.

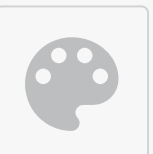
	
Non-stock Metallic	Non-stock RAL

Available in:
 • **AAMA 2604** Color
 •• **AAMA 2604** or **2605** Color

* Non stock, fee **upcharge**
 * This color was designed to pair with Armstrong color "WH" grid and trim.

4 Product Specifications

System Specs

Fin Material	12mm Soft Sound® (PET)	20GA Steel
Module Dimension	8'-11" Max Fin Length x 10' Ribs	11'-11" Max Fin Length x 10' Ribs
Fin Depth	5"-16"	5"-16"
Openness in Plan	89-92%	93-94%
Frame Material	Steel	
Fire Rating	ASTME84 - Class A	
Acoustics	True NRC®: Results Vary	
Attachment Method	3/8" Threaded Rod (By Others)	
Accessibility	Yes, Removable clips at each fin	

This product may be the subject of one or more patents or pending patent applications. See www.arktura.com/intellectual-property for related patent information.