



A R K T U R A



Atmosfera[®] Swell



Ceiling **Baffles**

Our Key Features

Swell's smooth geometric forms transform your thoughts and space into a tranquil oceanside paradise. Swell's gentle pattern adds excitement while capturing the aura of billowing clouds and the gentle swell of an active ocean. Perfect for a dramatic yet elegant design, Swell incorporates our Soft Sound® fins to a good job of quieting the noise of the waves lapping against the shore.



Reduce Noise & Enhance Acoustics

Atmosfera®'s Soft Sound® material reduces the impact of noise from everyday annoyances like ringing, typing, and chatter resulting in a more pleasant and productive environment. Atmosfera®'s material works in concert with the design to help reduce and control reverberations leaving a lasting impression at scales ranging from assembly halls to conference rooms.

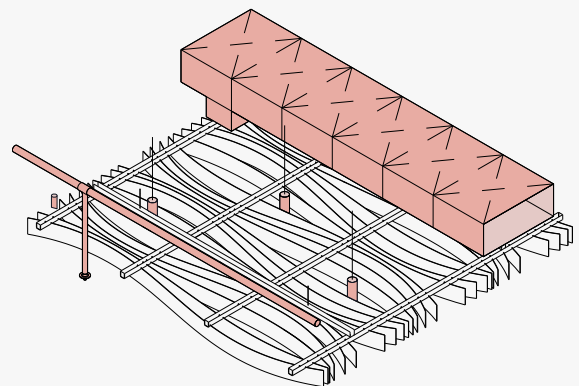

Open Accessibility in Plan

Atmosfera®'s open design makes integrating systems above or below the modules simple and feasible. Easily removable fins and open structure makes accessing lights, HVAC, rigging points, plumbing, AV equipment, and life safety systems easy for your maintenance team.



Scan the QR or Click to Learn More about Atmosfera®

Our Key Features

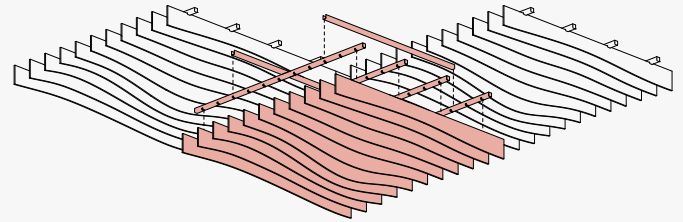
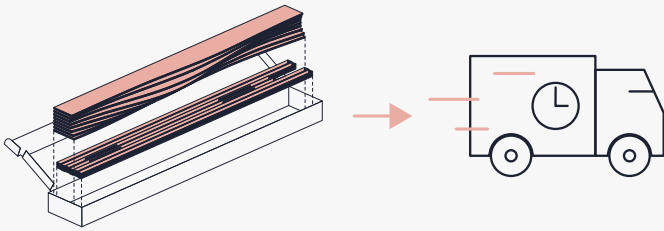

Faster Shipping & Installation

Because they're preconfigured, production starts as soon as you order. Once complete Atmosphera®'s easy-to-assemble modules are promptly shipped, helping you cut down installation times and meet your project deadlines.

Preconfigured Designs & Sizes

For a custom look without the custom price tag, pre-configured Atmosphera® modules offer innovative design impact with a quick and easy installation process. Achieve a cleaner design in a fraction of the time versus independently hung baffles.

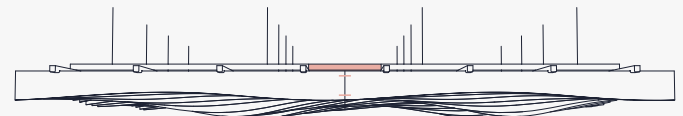

Easily Field Modifiable

This system allows for some simple modification that can allow it to adapt to your space without having to design a custom system.

Continuous Straight Baffles

Utilizing a hidden fin and frame alignment system Atmosphera provides continuity in all directions across your space. Our custom formulated material thickness and density ensures rigidity that limits deflection.

Inspiration



Add Subtle Waves and Dimension



Dynamic Lighting Effect



Available in Soft Sound® Wood Textures

Overview

1 Understanding the System

2 Available Finishes

3 Product Specifications

1 Understanding the System

Standard Module

Modules consist of fins made from Arktura's lightweight & durable Soft Sound® acoustical material supported by stainless steel ribs.

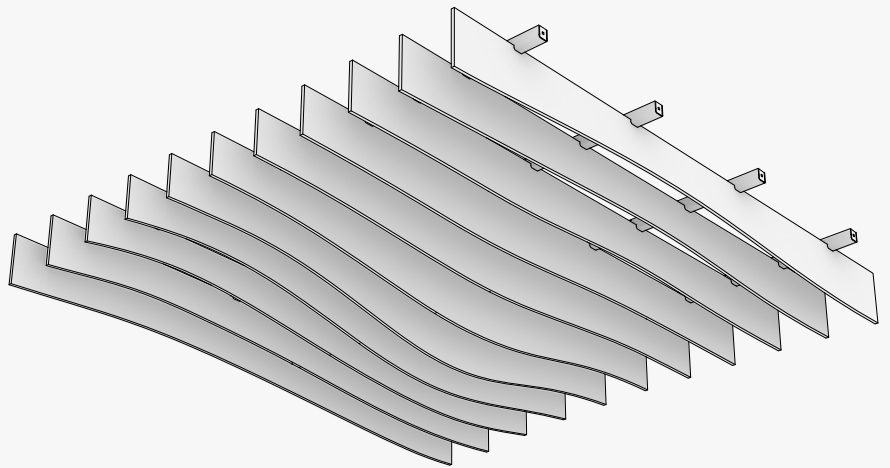

Multiple Modules

Modules can be seamlessly tiled in multiple directions in plan.

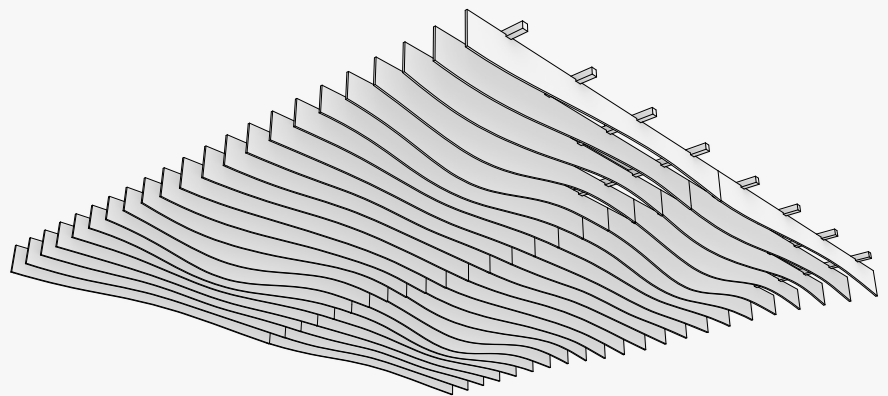

1 Understanding the System

Understanding the Module

Plan

Atmosfera® Swell lets you design linear layouts in plan. Create seamless designs for your desired look while adapting to and concealing building elements such as sensors, sprinklers, and lighting.

86% Open in Plan

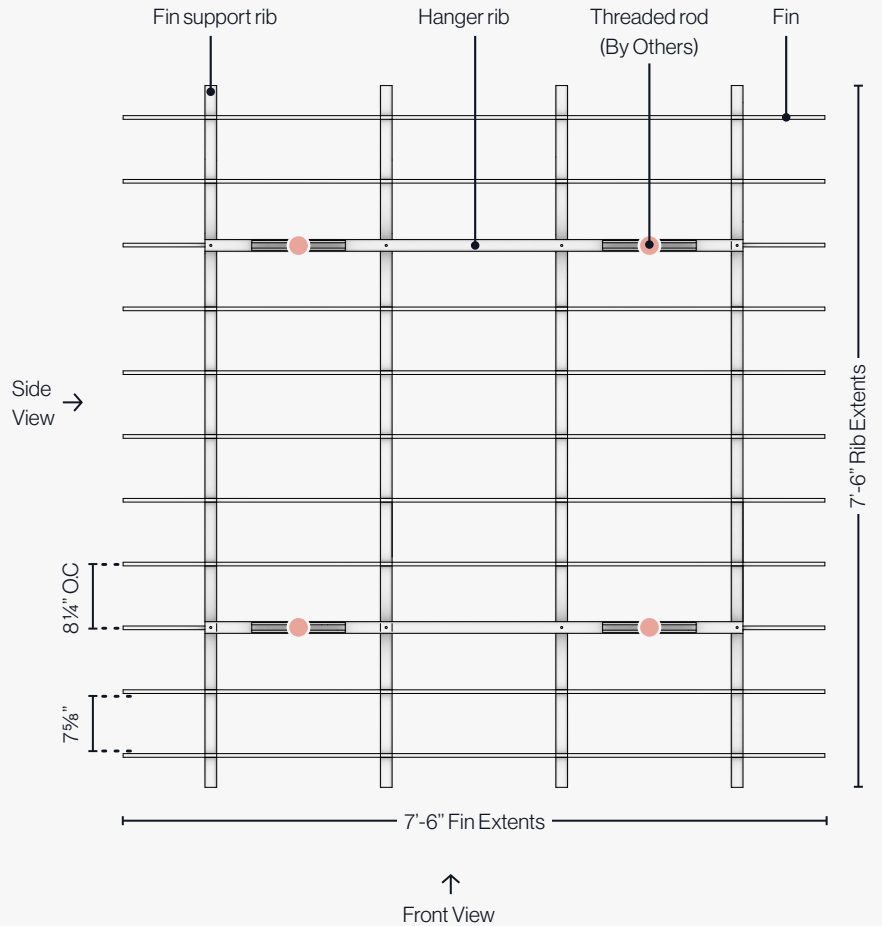

Elevations

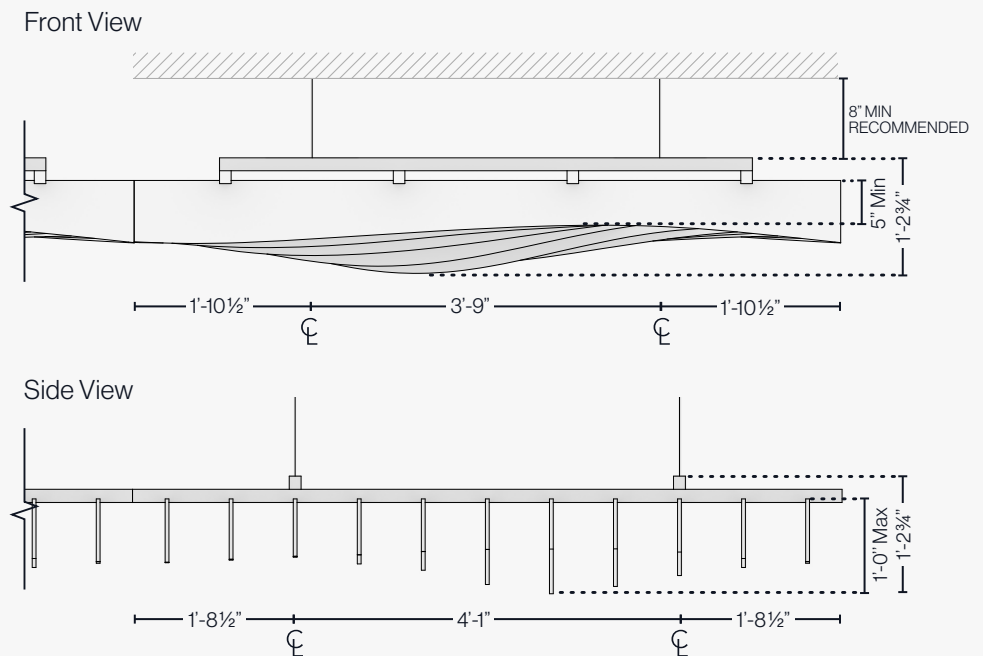

1 Understanding the System

Attachment Details

Atmosfera® Standard is designed for ease of install and assembly. Use available joining brackets to achieve seamless fin to fin connections across modules with ease.

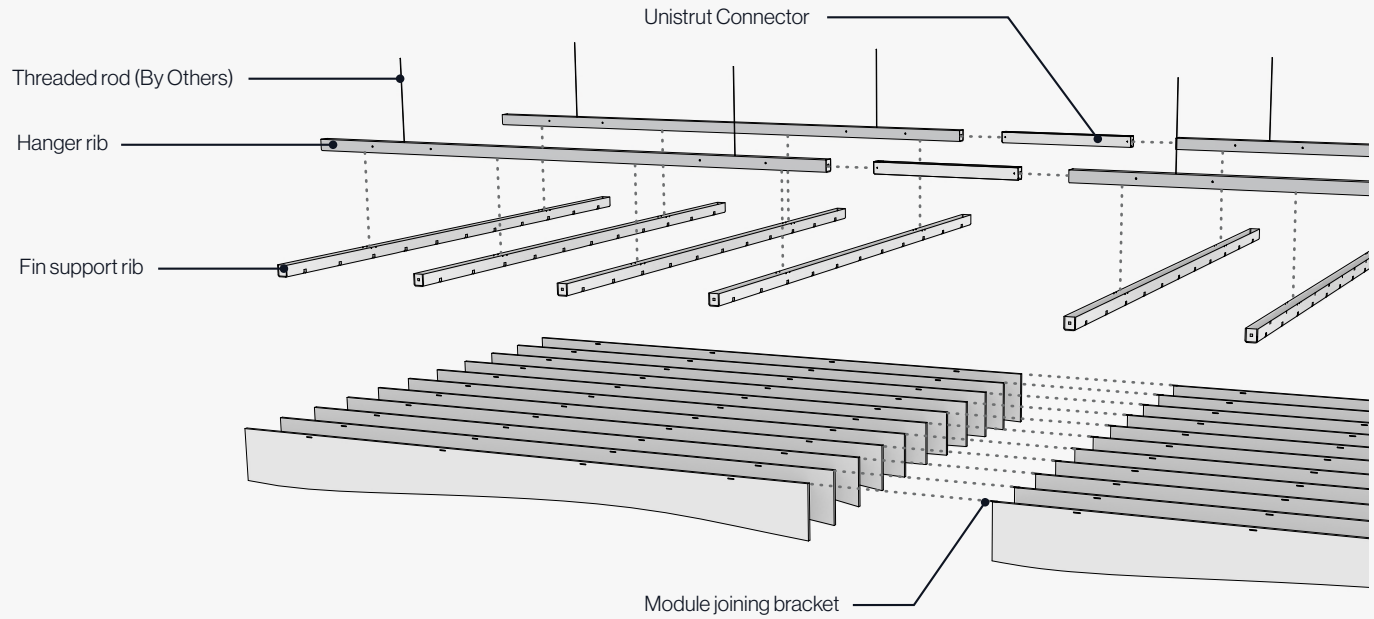

Multiple Modules Grid

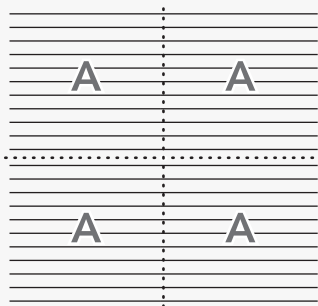

Unistrut Connector and Rib End to End Connection

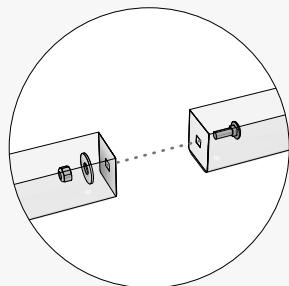

Cross-Module Alignment Pin

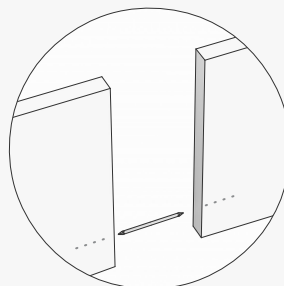

Module Joining Bracket

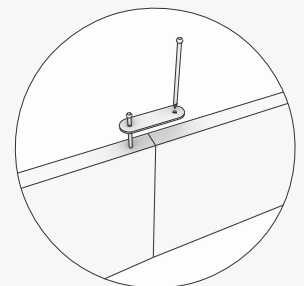

2 Available Finishes

Baffle Color

Soft Sound®
Vivids
Standard

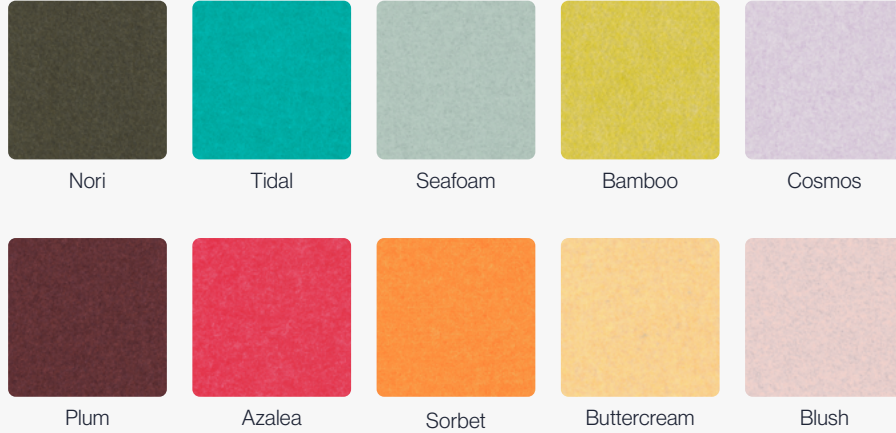

Soft Sound®
Elementals
Standard

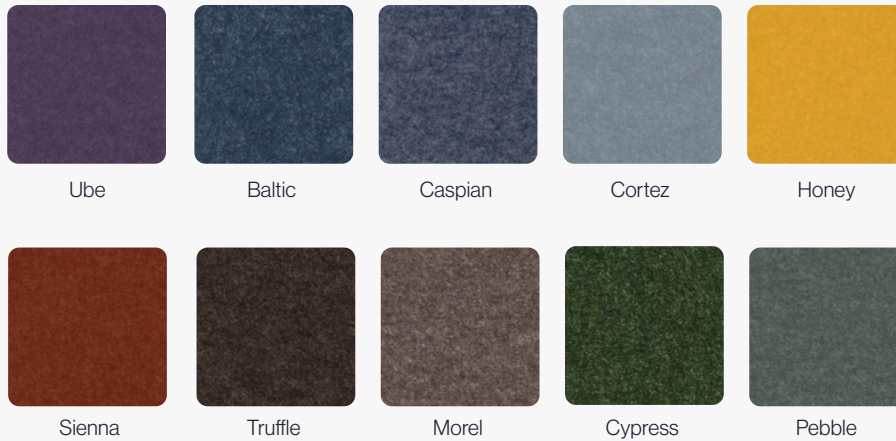

ⓘ Due to the nature of non-woven materials, light may pass through Soft Sound® in any thickness or color. A translucent appearance is most apparent in lighter colors and thin material when a light source is present behind the material. Arktura makes no claims or warranties about the material performing as opaque in any circumstance. To verify a products performance for light transmittance, a mockup of the specific intended use is recommended.

2 Available Finishes

Baffle Color

**Soft Sound®
Essentials**
Standard



**Soft Sound®
Wood Texture**
Premium

i As with natural wood, variation in color and grain is expected and grain will not align across panels.

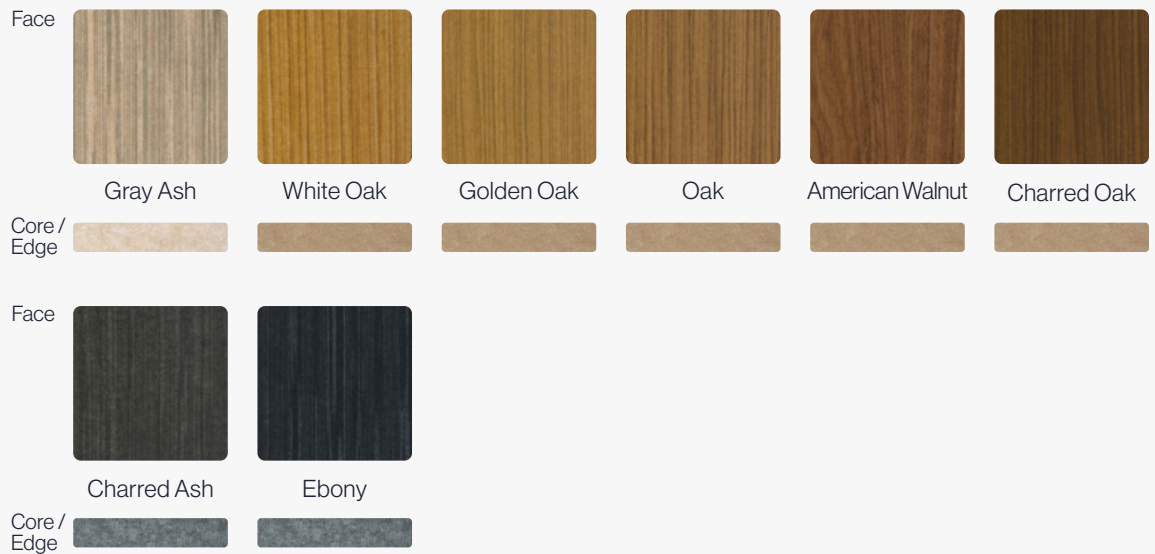

! Due to the nature of non-woven materials, light may pass through Soft Sound® in any thickness or color. A translucent appearance is most apparent in lighter colors and thin material when a light source is present behind the material. Arktura makes no claims or warranties about the material performing as opaque in any circumstance. To verify a products performance for light transmittance, a mockup of the specific intended use is recommended.

2 Available Finishes

Steel Ribs

Powder Coat
Standard Finish
Inspired by our
Vivids Collection



Seaweed
●



Oasis



Mint
●●



Tropica
●●



Moonwalk



Berry

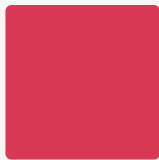

Ruby
●



Papaya
●

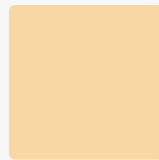

Lemonade
●●

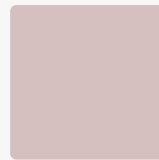

Pismo
●

Powder Coat
Standard Finish
Inspired by our
Elementals Collection



Garnet
●



Seaside
●



Haze



Seaglass
●



Harvest



Earthen
●●

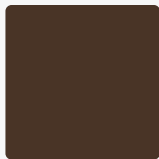

Cacao
●●



Terra
●●



Evergreen
●



Basalt
●●

Available in:

- **AAMA 2604** Color
- **AAMA 2604** or **2605** Color

* Non stock, fee **upcharge**



2 Available Finishes

Steel Ribs



Powder Coat
Standard Finish
Inspired by our
Essentials Collection

					
T-Grid White* (Matte) ••	Arktura White (Matte) ••	Brilliant White* (Gloss) •	Silver Metallic (Semi Gloss) ••	Jet Black (Matte) ••	
					
Aviator Gray (Gloss) ••	Aviator Gray (Matte) ••	Steel Gray ••	Shadow ••	Midnight ••	Coffee •
					
Raw Umber •	Caramel ••	Sandstone ••	Oat ••	Sunflower* •	Torch •
					
Spirit Red (Matte) •	Redwood •	Boysenberry •	Azure* •	Blue Steel* •	Harbor Blue •
					
Forest Green ••	Hartford Green •				

Powder Coat
Premium Metallic
Finish

		
Chilled Champagne (Semi Gloss) ••	Sun Kissed Bronze •	Burnished Bronze (Semi Gloss) ••

Custom Powder Colors
We offer premium non-stock RAL and custom color match options as well. Contact your sales rep for more information.

	
Non-stock Metallic	Non-stock RAL

Available in:

- AAMA 2604 Color
- AAMA 2604 or 2605 Color

* Non stock, fee **upcharge**

* This color was designed to pair with Armstrong color "WH" grid and trim.

3 Product Specifications & Certifications

System Specs

Dimensions (WxLxD)	7'-6" x 7'-6" x 1'
Fin Material	12mm Soft Sound® (PET)
Frame Material	Steel
Openness in Plan	86%
Fire Rating	ASTM E84 - Class A
Attachment Method	3/8" Threaded Rod (By Others)
Accessibility	Yes, removable Clips at Each Fin
Trimmability	Yes, per installation manual

This product may be the subject of one or more patents or pending patent applications.
See www.arktura.com/intellectual-property for related patent information.