



A R K T U R A

Soft Sound[®] Tiles



Standard Wall Panels

Inspiration



Mix and match Soft Sound® Tiles in various size and color options to create unique layouts



Mitigate excess noise in the office



Stagger tiles linearly or create an abstract arrangement

Overview

1 Understanding the System

3 Product Specifications

2 Available Finishes

1 Understand the System

Standard Modules

Soft Sound® Tiles come in five sizes that allow for a variety of configurations. Arrow indicates direction of wood grain for optional Soft Sound® Wood Textures.

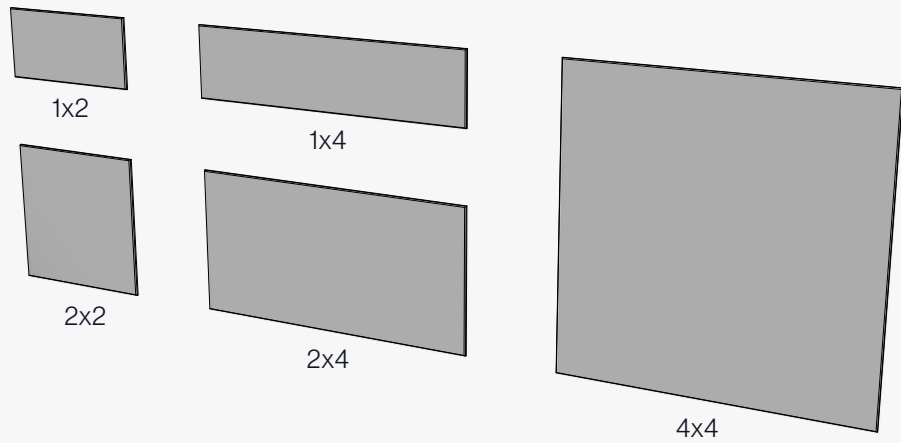

Multiple Modules

Create an acoustic collage using various SoftScreen® Groove panels in different colors and sizes for a truly unique layout.

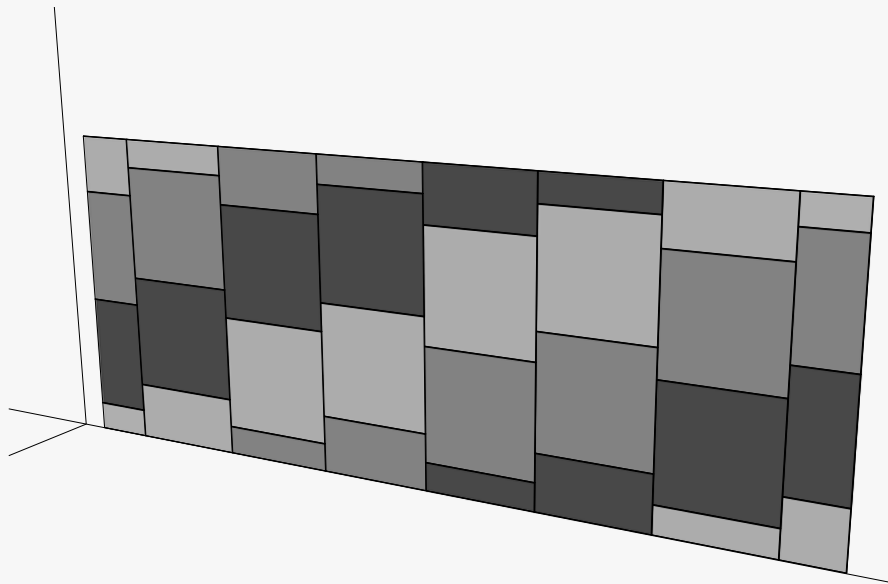

1 Understanding the System

Dimensions

Soft Sound® can be installed with an air gap between the wall and the panels for higher acoustic performance.

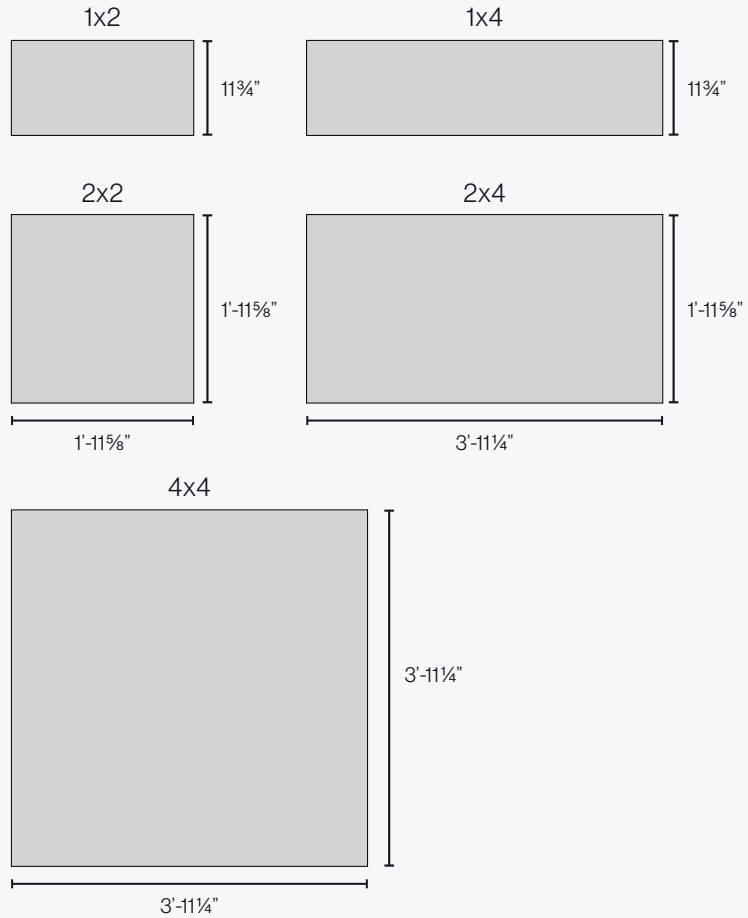

Section

Soft Sound® Tiles are beveled at a 30° angle, creating a V-groove when modules are tiled together."

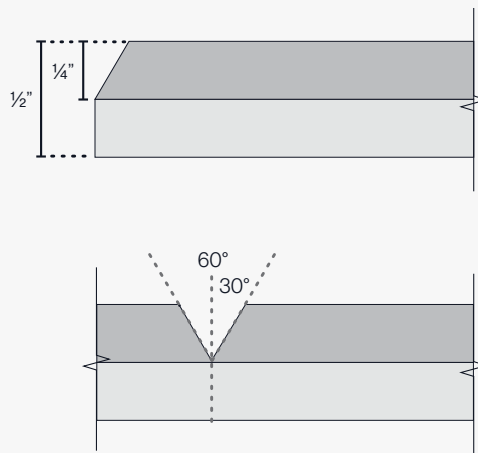

Looking for a more dynamic textured finish wall panel? Check out our Soft Sound Groove Coverings line.

① Understanding the System

Design Inspiration

Tile a near countless arrangement of patterns and designs, with the unlocked creative potential of Soft Sound® Tiles. Specify multiple colors from a vast library of finish options and premium wood finishes.

Offered in five distinct sizes to be used in tandem with one another, creating unique configurations. From linear designs, staggered blocks, checkerboards, or abstract layouts, with Soft Sound® Tiles, your imagination is the limit of creative design possibilities.

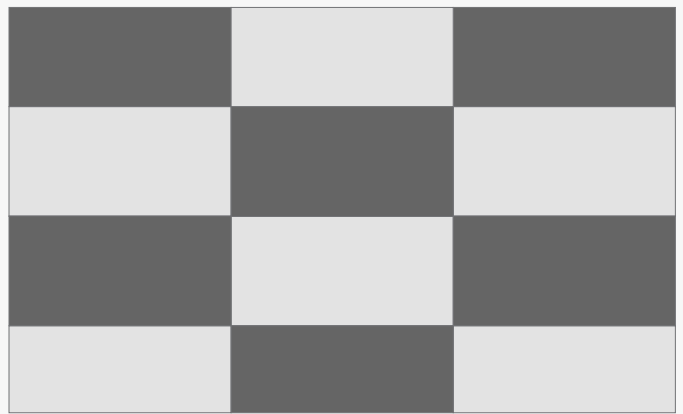
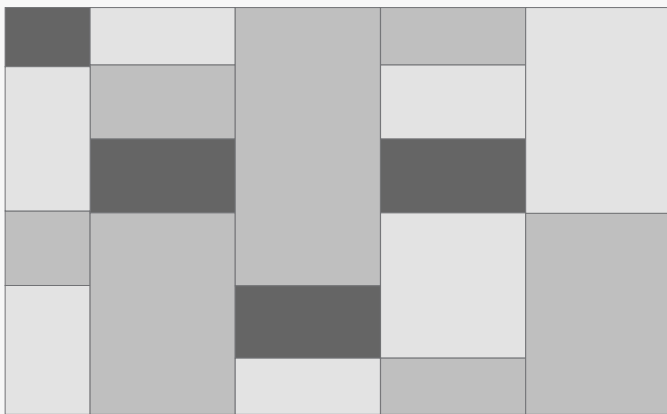
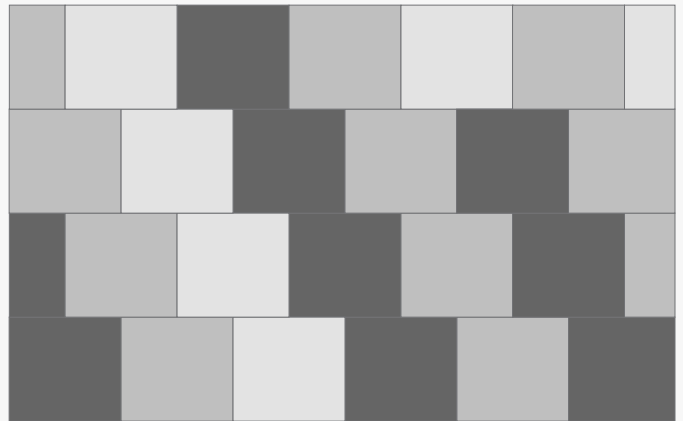
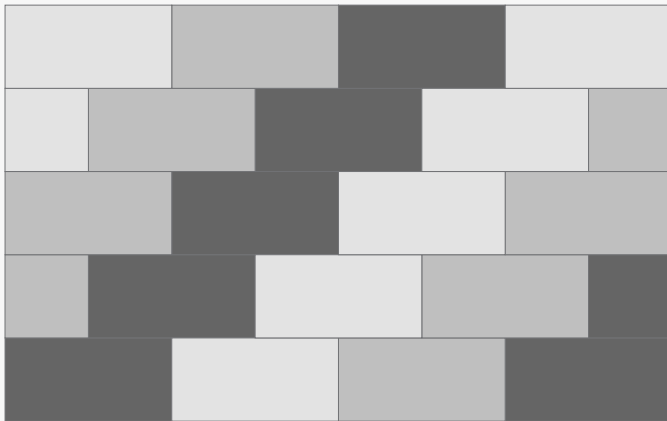
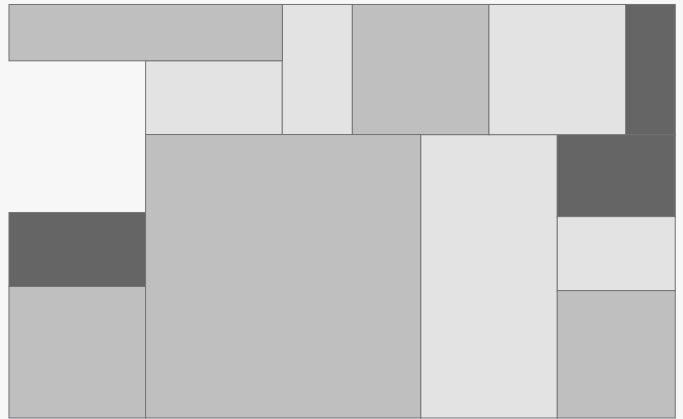
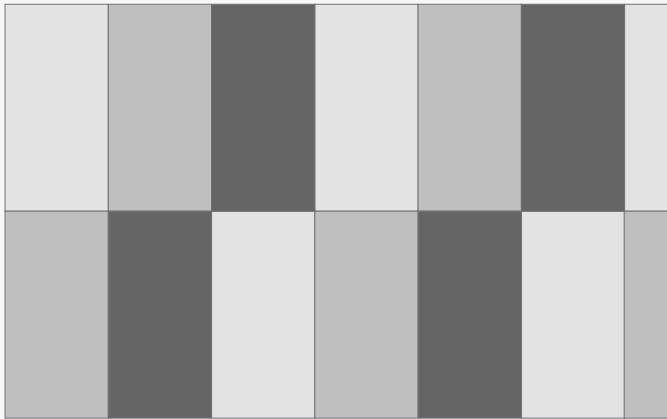

2 Available Finishes

Soft Sound® Panel

Soft Sound®
Vivids
Standard

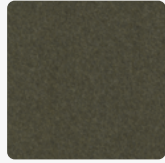

Nori



Tidal



Seafoam

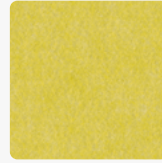

Bamboo

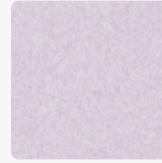

Cosmos

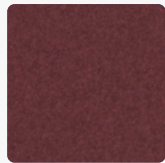

Plum



Azalea

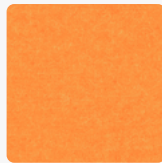

Sorbet

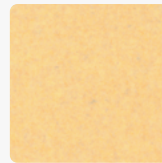

Buttercream

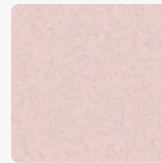

Blush

Soft Sound®
Elementals
Standard



Ube

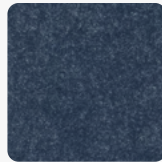

Baltic



Caspian

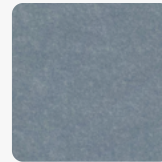

Cortez



Honey



Sienna



Truffle



Morel



Cypress

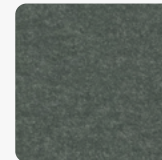

Pebble

 Due to the nature of non-woven materials, light may pass through Soft Sound® in any thickness or color. A translucent appearance is most apparent in lighter colors and thin material when a light source is present behind the material. Arktura makes no claims or warranties about the material performing as opaque in any circumstance. To verify a products performance for light transmittance, a mockup of the specific intended use is recommended.

2 Available Finishes

Soft Sound® Panel

**Soft Sound®
Essentials**
Standard



**Soft Sound®
Wood Texture**
Premium

 As with natural wood, variation in color and grain is expected and grain will not align across panels.

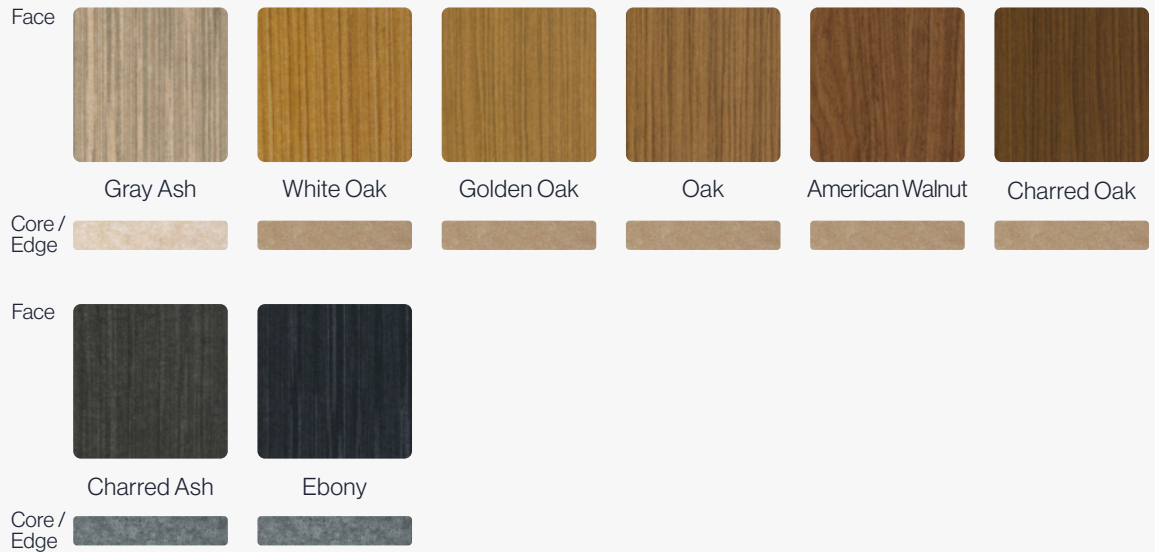

 Due to the nature of non-woven materials, light may pass through Soft Sound® in any thickness or color. A translucent appearance is most apparent in lighter colors and thin material when a light source is present behind the material. Arktura makes no claims or warranties about the material performing as opaque in any circumstance. To verify a products performance for light transmittance, a mockup of the specific intended use is recommended.

3 Product Specifications & Certifications

Product Specifications

Panel Size (WxHxD)	1x2 (1'-11 ⁵ / ₈ " x 11 ³ / ₄ " x 1/2") 1x4 (3'-11 ¹ / ₄ " x 11 ³ / ₄ " x 1/2") 2x2 (1'-11 ⁵ / ₈ " x 1'-11 ⁵ / ₈ " x 1/2") 2x4 (3'-11 ¹ / ₄ " x 1'-11 ⁵ / ₈ " x 1/2") 4x4 (3'-11 ¹ / ₄ " x 3'-11 ¹ / ₄ " x 1/2")
Material	12mm Soft Sound® (PET)
Fire Rating	ASTM E84 - Class A
Acoustics	True NRC®: 0.90
Direct Attachment	Adhesive