



A R K T U R A



# SoftGrid® Forge



Ceiling **Baffles**

# Our Key Features

Geometric linework expands in an impressive array, covering a ceiling in a functional style. Acoustic baffles intersect sporadically while also creating hexagonal structures of noise mitigation. This innovative layout is designed for sound absorption and noise reduction in any space, making it ideal for offices, schools, hospitals, and other commercial buildings. Specify these angular modules in a variety of Soft Sound® finishes including Duo Tone and premium wood textures.



## Reduce Noise & Enhance Acoustics

SoftGrid®'s Soft Sound® material reduces the impact of noise from everyday annoyances like ringing, typing, and chatter resulting in a more pleasant and productive environment. SoftGrid®'s material works in concert with the design to help reduce and control reverberations leaving a lasting impression at scales ranging from assembly halls to conference rooms.

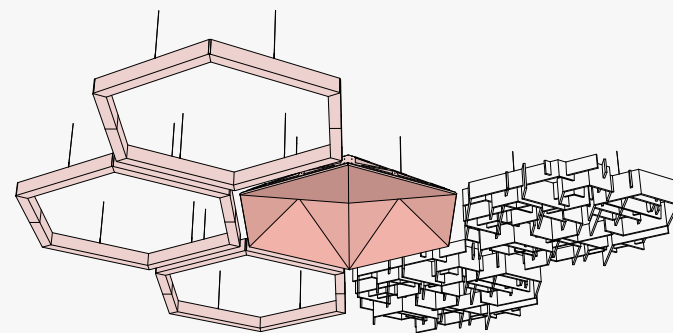

## Compatible with Hexagonal Systems

SoftGrid® Forge's modules are compatible with other Hexagonal systems from Arktura including SoftGrid® Deca, SoftShapes™ Hex, and SoundStar® to fully immerse spaces in acoustic attenuation.

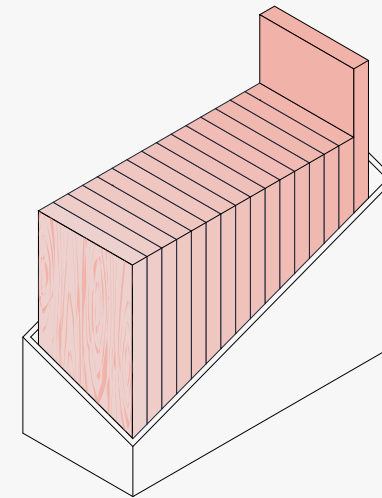

## Expansive Soft Sound® Library

Choose from a large library of Soft Sound® colors and wood textures. Mix and match colors to accent fins and complement the color scheme of your space.

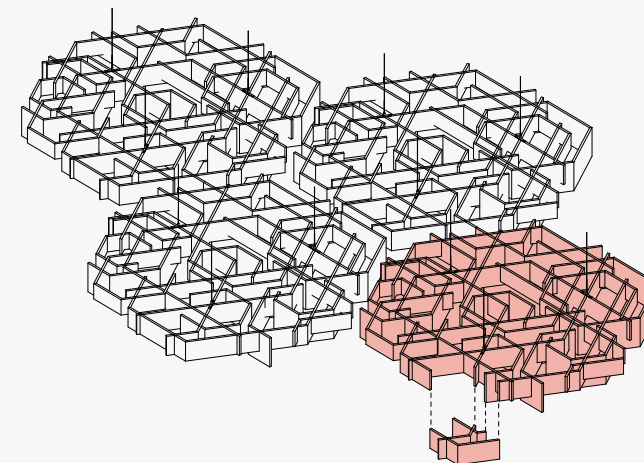

## Field Modifiable

SoftGrid® modules can be trimmed down to a minimum of four fin intersections. By rearranging our adjustable hangers, we make it easy for you to specify standard modules that can be easily field-modified around anticipated or unforeseen site conditions during install.

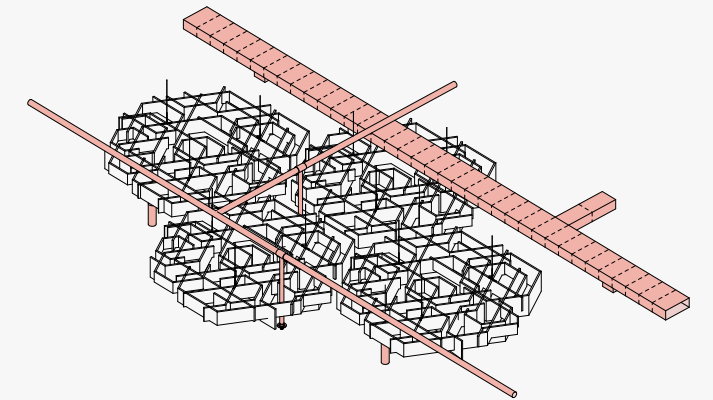

## Open Plan Accessibility

SoftGrid®'s open grid design makes integrating systems above or below the modules simple and feasible. Easily removable fins and open structure makes accessing lights, HVAC, rigging points, plumbing, AV equipment, and life safety systems easy for your maintenance team.

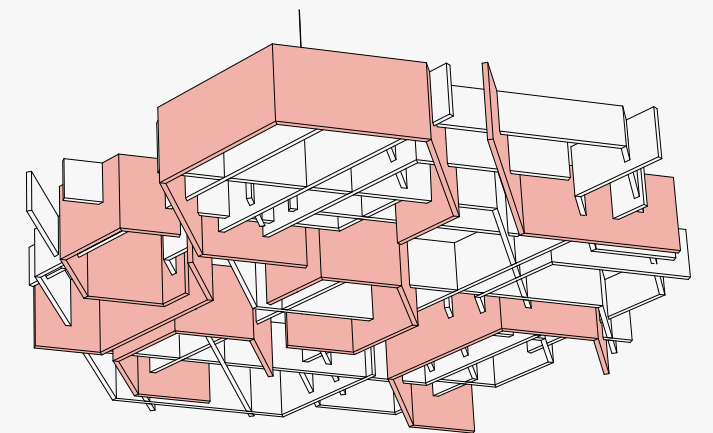

## Duo Capability

Add new dimensions of style, mix colors and textures in an expanding range of dynamic combinations to fully achieve your design intent. Perfect for incorporating branding or a dynamic two-tone impression.



Scan the QR or Click to Learn More about SoftGrid®



# Inspiration

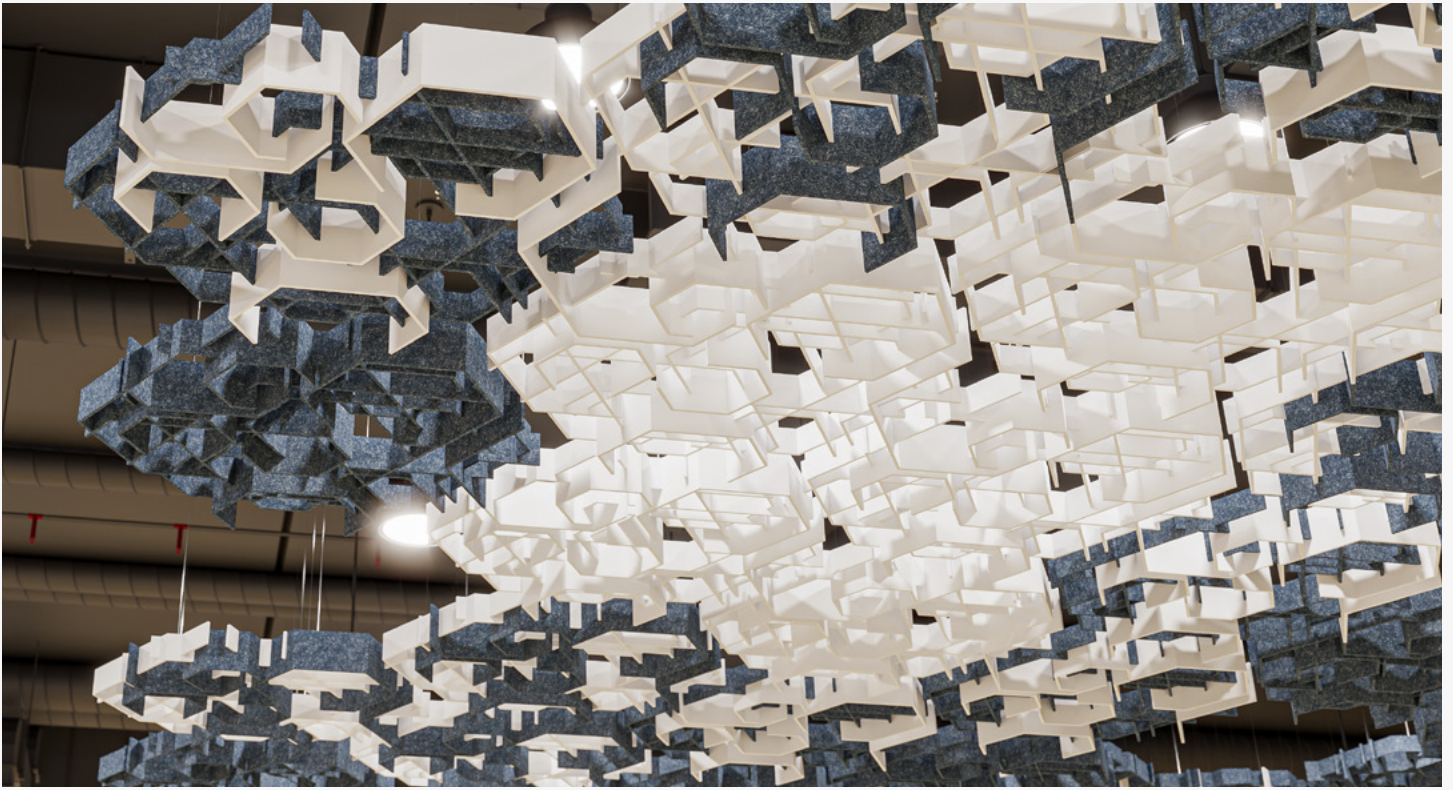

The hexagonal form factor of Forge provides multiple angles to attenuate noise



Intricate linework provides an acoustic focal point in any space



Create relaxing wellness centered spaces

# Overview

1 Understanding the System

2 Available Finishes

3 Product Specifications

## 1 Understanding the System

### Standard Module

Modules are made from Arktura's lightweight & durable Soft Sound® acoustical material with stainless steel brackets.

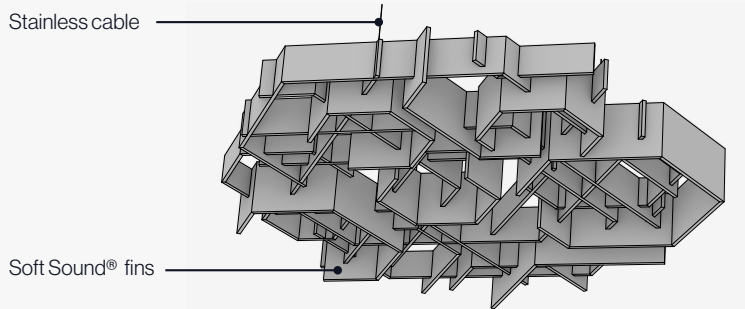

### Designing with Modules

Modules can be tiled in multiple directions in plan utilizing their hexagonal geometry. Modules may all be stepped in section or placed in a continuous plane.

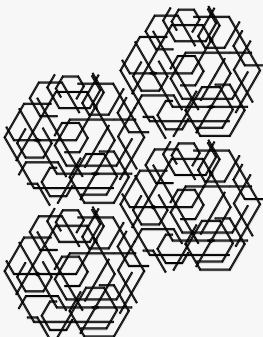
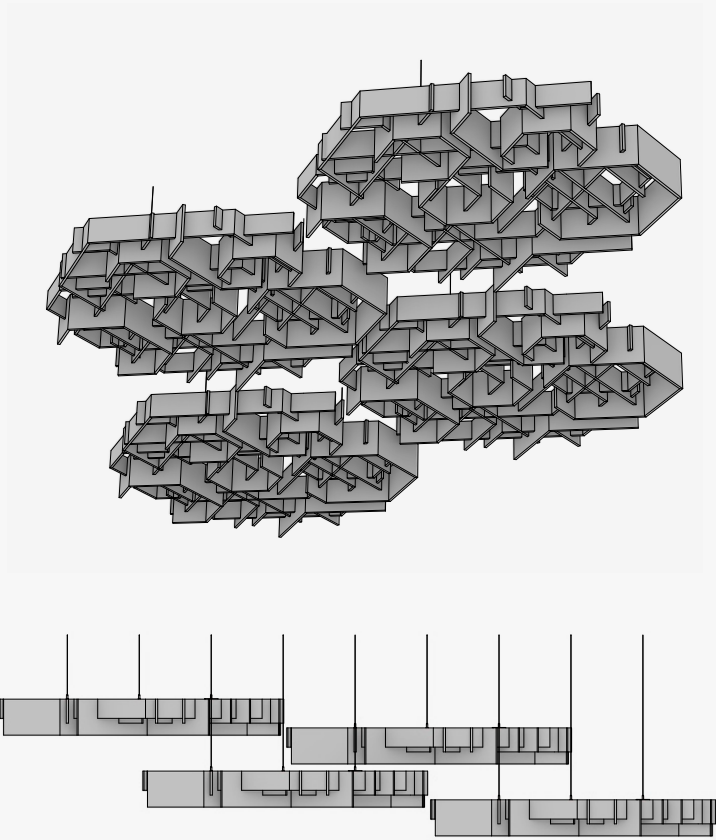

1 Understanding the System

Understanding the Module

**Plan**

85% Open in Plan

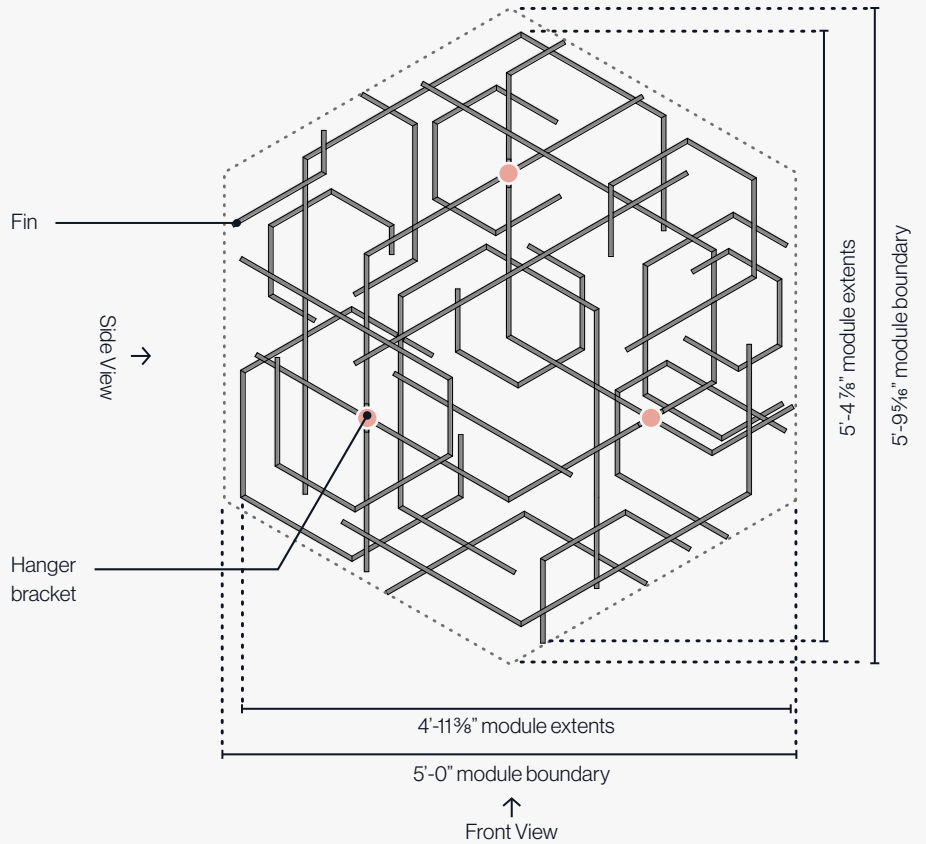

**Elevations**

Fin depth varies from 4" to 7 1/2" deep.

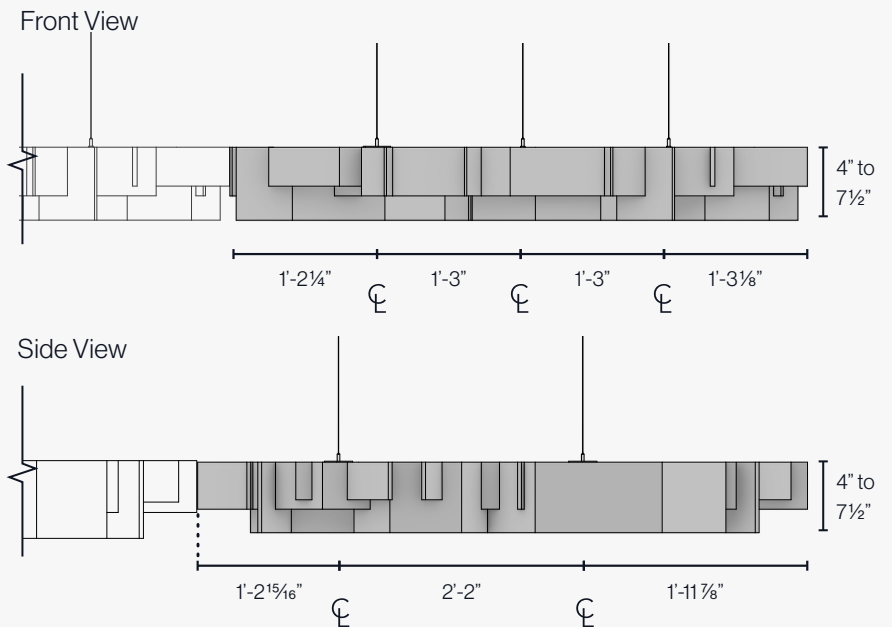



# 1 Understanding the System

## Attachment Details

To minimize the visual impact of our hanging system, we provide 1/32" stainless cables and a micro quick-release wire clamp with hanging brackets at 3 locations.

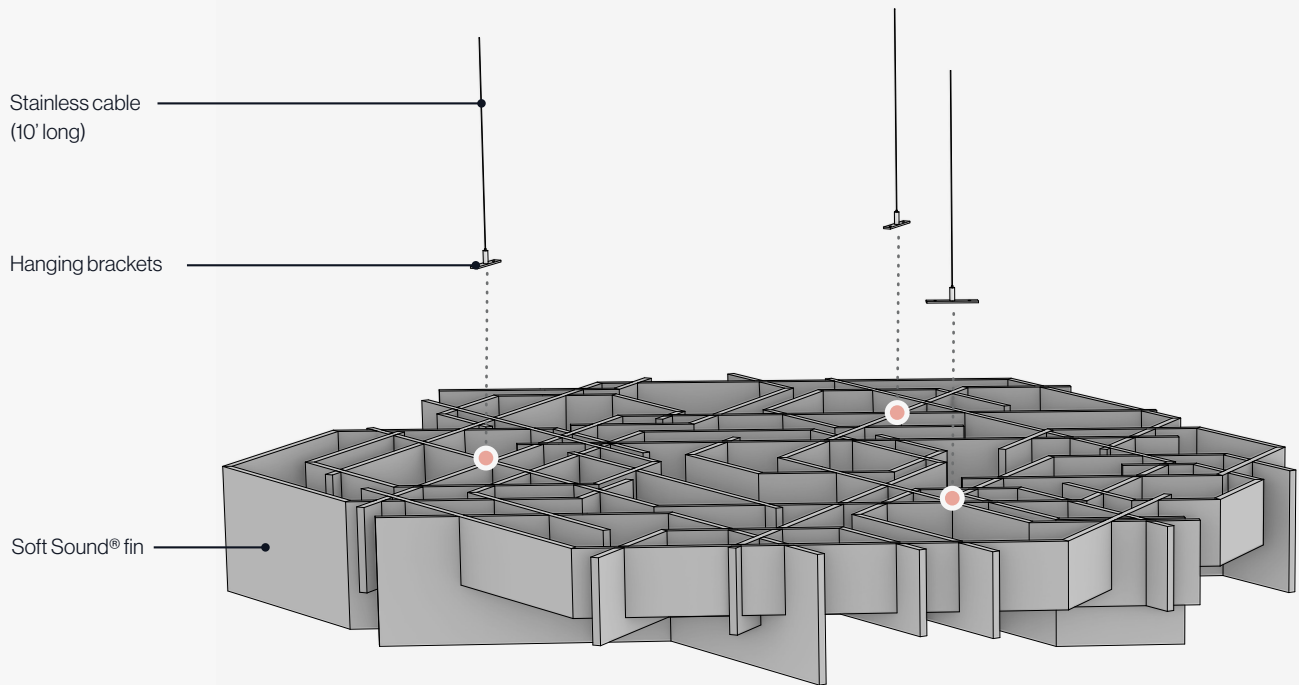

Hanging Bracket Attachment

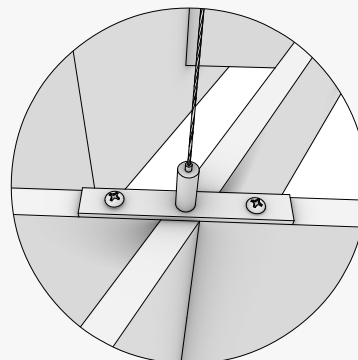

1 Understanding the System

Combining With Other Products

Create drama in your design by mixing other hexagonal SoftGrid®, SoundStar® and SoftShapes™ modules together.

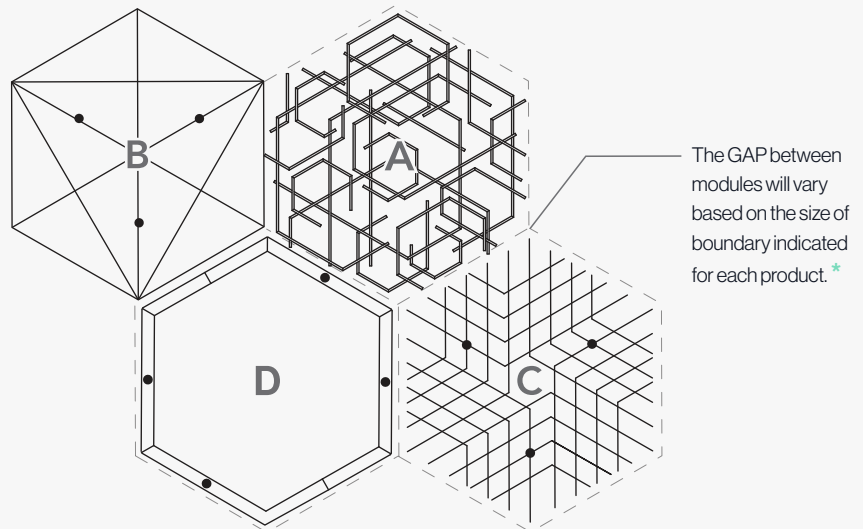
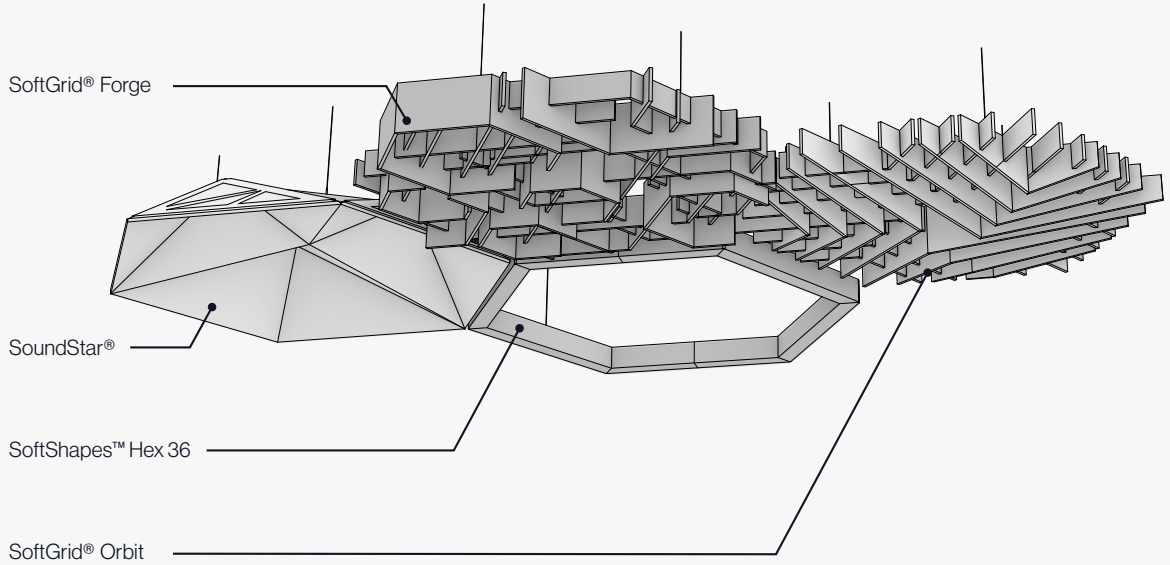

- SoftGrid® Forge (A)
- SoundStar® (B)
- SoftGrid® Orbit (C)
- SoftShapes™ Hex 36 (D)

\* To combine SoftGrid® Forge with other products please contact your Arktura Rep. to request Product Installation Manuals

## 2 Available Finishes

### Baffle Color

**Soft Sound®  
Elementals**  
Standard

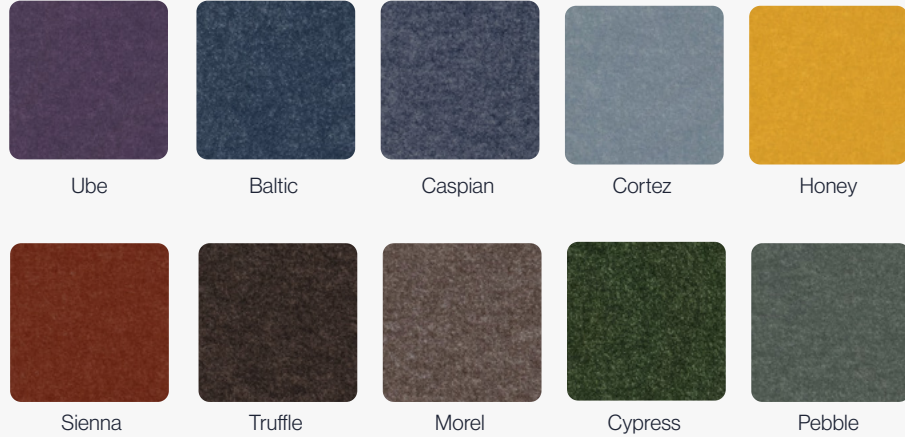

**Soft Sound®  
Wood Texture**  
Premium

**i** As with natural wood, variation in color and grain is expected and grain will not align across panels.

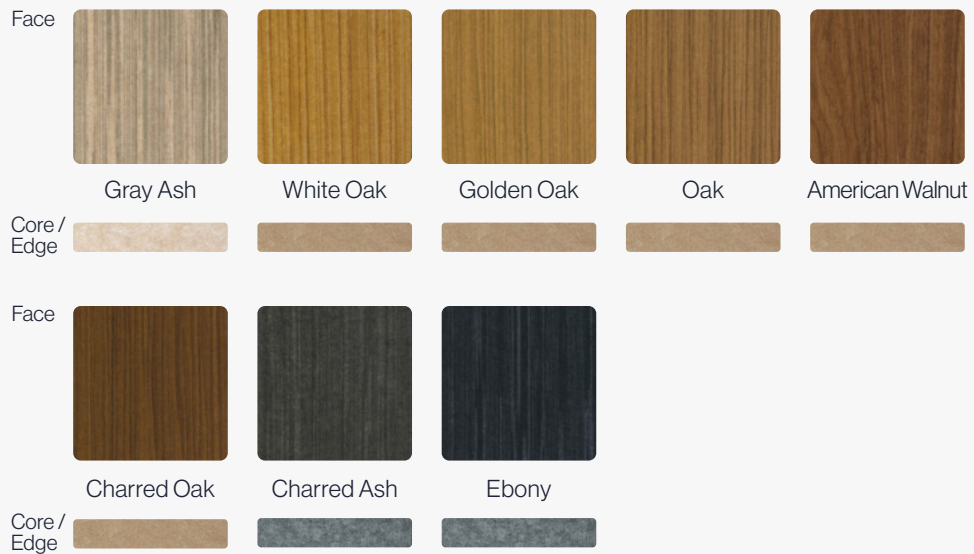

**!** Due to the nature of non-woven materials, light may pass through Soft Sound® in any thickness or color. A translucent appearance is most apparent in lighter colors and thin material when a light source is present behind the material. Arktura makes no claims or warranties about the material performing as opaque in any circumstance. To verify a products performance for light transmittance, a mockup of the specific intended use is recommended.



2 Available Finishes

Baffle Color

**Soft Sound®  
Essentials  
Standard**

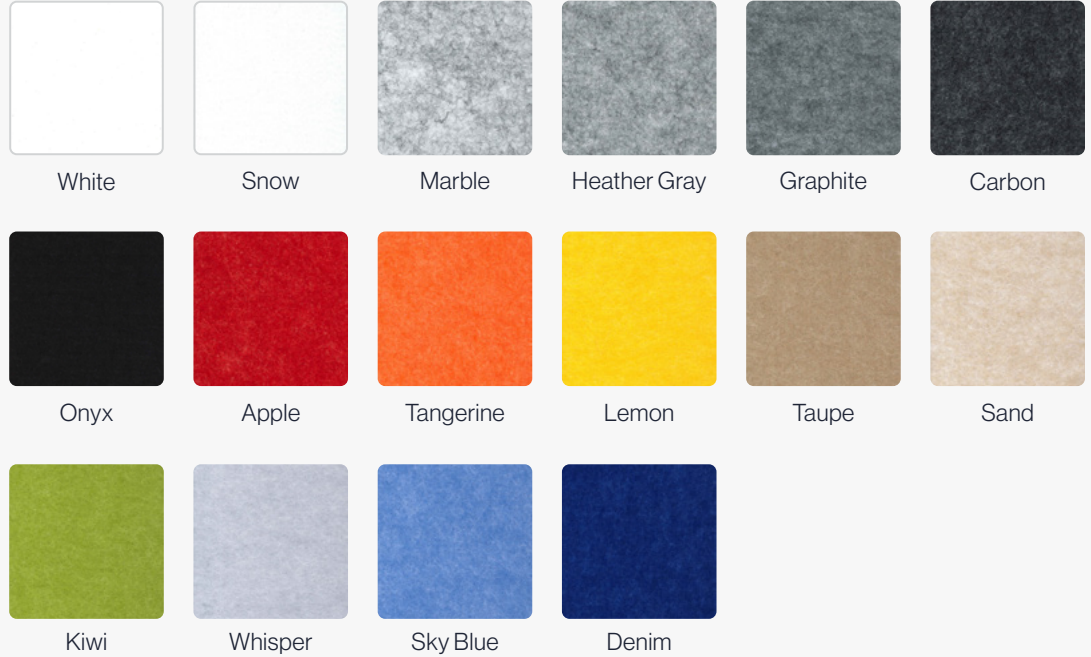

**Duo Tone**  
Optional

Select a primary and secondary color to switch up each module.

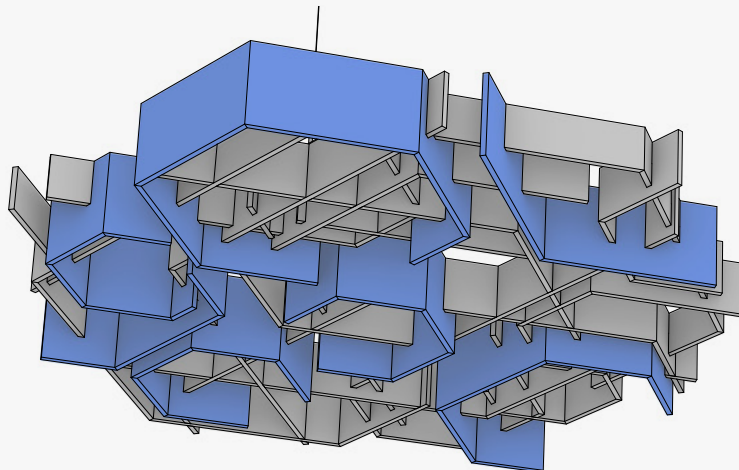

⚠ Due to the nature of non-woven materials, light may pass through Soft Sound® in any thickness or color. A translucent appearance is most apparent in lighter colors and thin material when a light source is present behind the material. Arktura makes no claims or warranties about the material performing as opaque in any circumstance. To verify a products performance for light transmittance, a mockup of the specific intended use is recommended.

### 3 Product Specifications & Certifications

#### System Specs

<b>Dimensions (WxLxD)</b>	5'-9 <sup>5</sup> / <sub>16</sub> " x 5' x (Min. 4" Max. 7 <sup>1</sup> / <sub>2</sub> "
<b>Material</b>	12mm Soft Sound® (PET), Stainless Steel
<b>Openness in Plan</b>	85%
<b>Fire Rating</b>	ASTM E84 - Class A
<b>Acoustics</b>	True NRC® 0.80 (F-100 Method)
<b>Attachment Method</b>	1/32" Stainless Cable and Hardware
<b>Accessibility</b>	Yes, quick release cables
<b>Trimmability</b>	Yes, per installation manual

Patent Pending  
Copyright ©2023 Arktura LLC. All rights reserved.

# Product Line

## Design Options

Select the style that best suits your vision and project needs. Pick from a variety of designs, all made from our Soft Sound® acoustical material, to provide high performance sound attenuation while enhancing aesthetics.

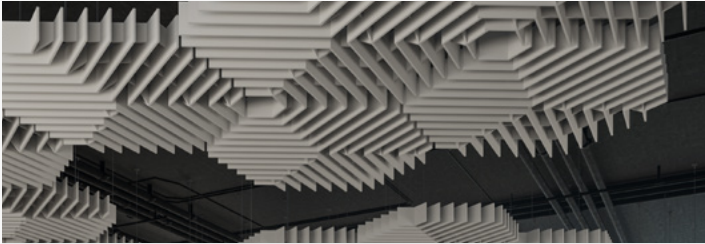

SOFTGRID® DECA

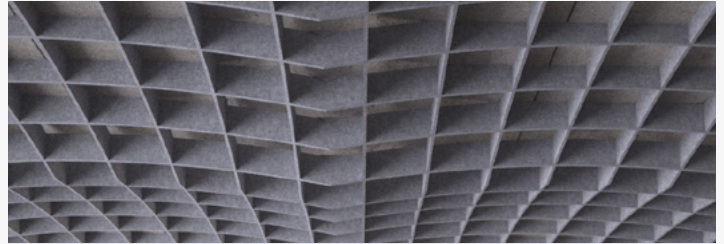

SOFTGRID® DOME



SOFTGRID® FLUX



SOFTGRID® FORGE



SOFTGRID® NEXUS



SOFTGRID® ORBIT



SOFTGRID® ROUND

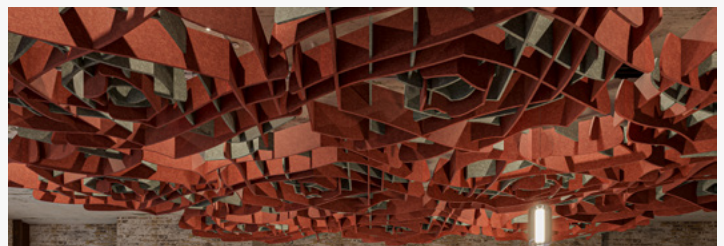

SOFTGRID® ROSETTE



SOFTGRID® SINE



SOFTGRID® SCALE



# Product Line

## Design Options

Select the style that best suits your vision and project needs. Pick from a variety of designs, all made from our Soft Sound® acoustical material, to provide high performance sound attenuation while enhancing aesthetics.

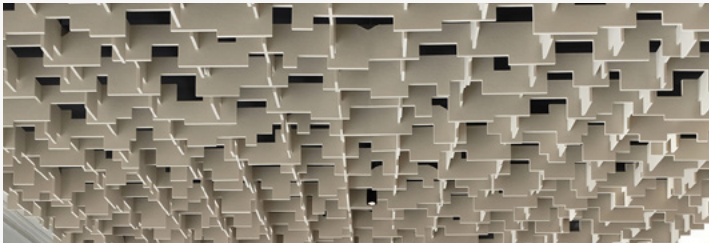

SOFTGRID® SKYLINE



SOFTGRID® SQUARE



SOFTGRID® SWITCH

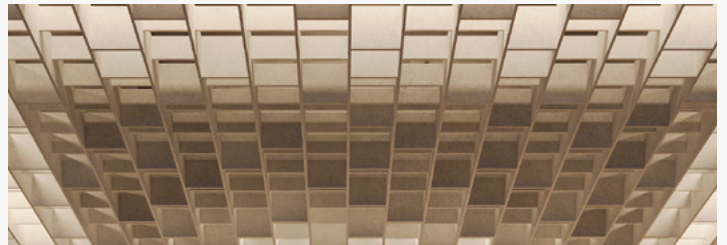

SOFTGRID® TEMPO



SOFTGRID® TILT

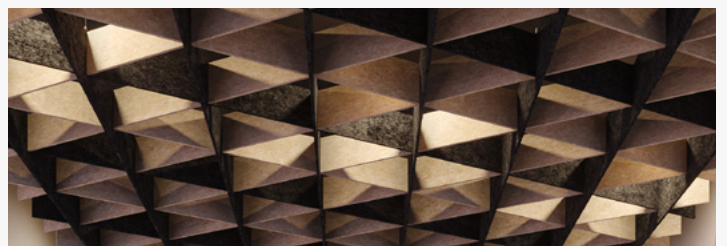

SOFTGRID® TRELLA

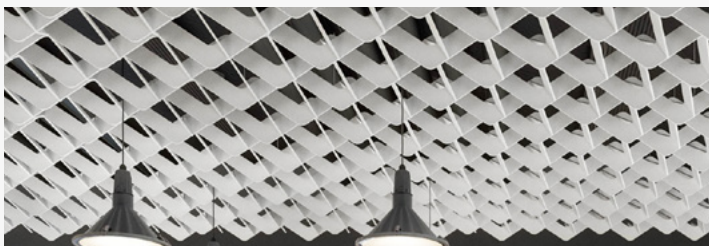

SOFTGRID® WAVE